

PRODUCT SPECIFICATIONS

Elkay SwirlFlo® Bi-Level Reverse Fountain Non-Filtered, Non-Refrigerated Freeze Resistant Stainless. Features shall include Freeze Resistant. Furnished with Vandal Resistant bubbler. Product shall be Wall Mount (On Wall), for Indoor + Outdoor applications, serving 2 station(s). Unit shall be lead-free design which is certified to NSF/ANSI 61 & 372 (lead free) and meets Federal and State low-lead requirements.

Special Features:	Freeze Resistant
Finish:	Stainless Steel
Power:	No Electrical Required
Bubbler Style:	Vandal Resistant
Mounting Type:	Wall Mount (On Wall)
Chilling Capacity:	Non-refrigerated
Dimensions (L x W x H):	38-1/2" x 19" x 21-15/16"
Approx. Shipping Weight:	100 lbs.
Installation Location:	Indoor + Outdoor
No. of Stations Served:	2

**When used in non-temperature controlled environments, unit(s) must be adequately winterized and/or protected from extreme heat to prevent damage where climates dictate.

- Freeze Resistant:
 - Depending on specific installation, freeze resistant system is located either below frost line or in temperature controlled space.



Included with Product: Fountain with Back Plate, Freeze Resistant Box, Surface Mounting

▼ **Ships in multiple boxes.**

AMERICAN PRIDE. A LIFETIME TRADITION. Like your family, the Elkay family has values and traditions that endure. For almost a century, Elkay has been a family-owned and operated company, providing thousands of jobs that support our families and communities.



PRODUCT COMPLIANCE

- ADA & ICC A117.1
- ASME A112.19.3/CSA B45.4
- Buy American Act
- NSF/ANSI 61 & 372 (lead free)



Complies with ADA & ICC A117.1 accessibility requirements when installed according to the requirements outlined in these standards. Installation may require additional components and/or construction features to be fully compliant. Consult the local Authority Having Jurisdiction if necessary.

- [Installation Instructions \(PDF\) - 98010C](#)
- [Installation Instructions \(PDF\) - 97566C](#)
- [Installation Instructions \(PDF\) - 97696C](#)

Water Systems are warranted for 12 months from date of installation. **Warranty pertains to drinking water applications only. Non-drinking water applications are not covered under warranty.**
[Warranty \(PDF\)](#)

PART: _____ QTY: _____

PROJECT: _____





CONTACT: _____

DATE: _____

NOTES: _____

APPROVAL: _____

In keeping with our policy of continuing product improvement, Elkay reserves the right to change product specifications without notice. Please visit elkay.com for the most current version of Elkay product specification sheets. This specification describes an Elkay product with design, quality, and functional benefits to the user. When making a comparison of other producers' offerings, be certain these features are not overlooked.

Optional Accessories		
EWF172	Elkay WaterSentry VII Filter Kit (Coolers + Fountains) Spec Sheet (PDF)	
AP99	Elkay Access Panel 9" x 9" x 6" Spec Sheet (PDF)	
LKAPR1	Elkay Cane Apron for SwirlFlo Gray Spec Sheet (PDF)	
98481C	Accessory - Bubbler Kit Water-Efficient Vandal-Resistant Spec Sheet (PDF)	

In keeping with our policy of continuing product improvement, Elkay reserves the right to change product specifications without notice. Please visit elkay.com for the most current version of Elkay product specification sheets. This specification describes an Elkay product with design, quality, and functional benefits to the user. When making a comparison of other producers' offerings, be certain these features are not overlooked.

INSTALLER NOTE

This drinking fountain is furnished with a bubbler and valve including all connecting fittings which are manufactured of completely lead free material. Shut off valve (not furnished) to accept 3/8" O.D. unplated copper tube.

OPERATION OF QUICK CONNECT FITTINGS

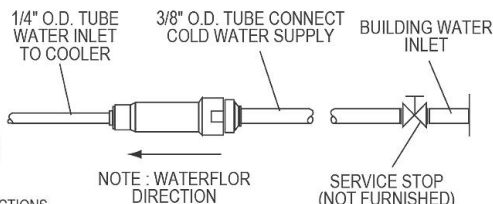
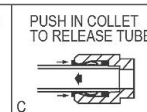
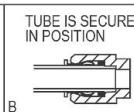
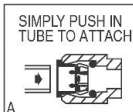

WARNING: The free-resistant box must be installed on an interior heated wall where the temperature does not drop below 50° F (10° C). The front of the box must have unobstructed air flow. Failure to maintain the interior wall temperature and the inside of the freeze resistant box above 50° F (10° C) can result in damage to the box which could result in unrestricted water flow.

These products are designed to operate on 20 psi to 105 psi supply line pressure. Simultaneous operation of both bubblers on a bi-level unit may not be possible depending on water supply pressure. If simultaneous operation is desired, please ensure a minimum of 50 psi supply.

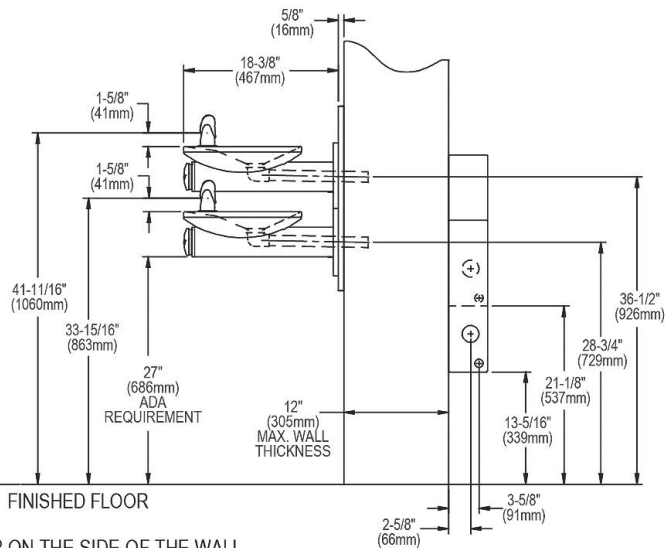
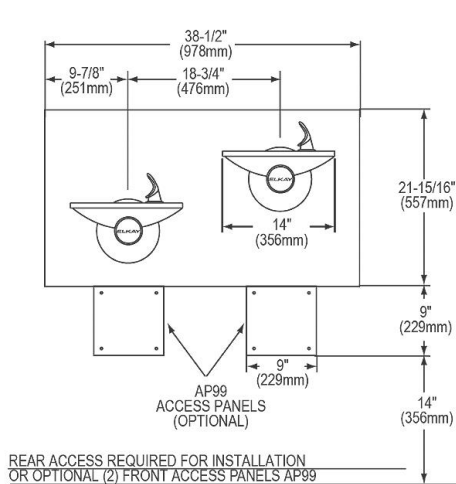
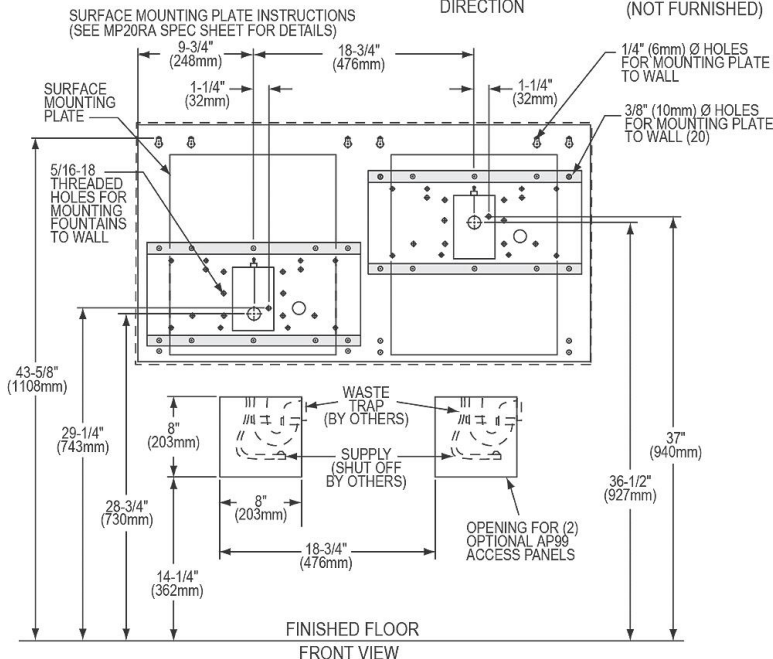
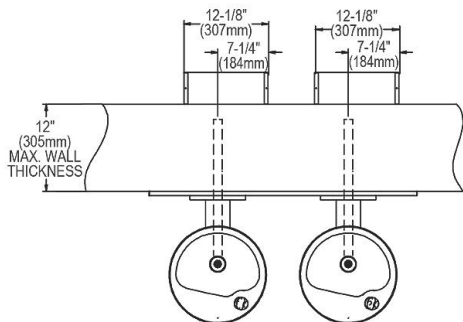

*NOTE: ALL DIMENSIONS ARE TAKEN FROM THE FINISHED FLOOR ON THE SIDE OF THE WALL THAT THE FOUNTAIN IS INSTALL ON.

NOTE: REINFORCE WALL IN SHADED AREAS.

In keeping with our policy of continuing product improvement, Elkay reserves the right to change product specifications without notice. Please visit elkay.com for the most current version of Elkay product specification sheets. This specification describes an Elkay product with design, quality, and functional benefits to the user. When making a comparison of other producers' offerings, be certain these features are not overlooked.