

PRODUCT SPECIFICATIONS

Elkay Cooler Wall Mount Non-Filtered Non-Refrigerated Stainless. Furnished with Flexi-Guard® Safety Bubbler. Mechanical Top Bubbler Button activation. Product shall be Wall Mount (On Wall), for Indoor applications, serving 1 station(s). Unit shall be lead-free design which is certified to NSF/ANSI 61 & 372 (lead free) and meets Federal and State low-lead requirements.



Finish:	Stainless Steel
Power:	No Electrical Required
Bubbler Style:	Flexi-Guard® Safety Bubbler
Activation by:	Mechanical Top Bubbler Button
Mounting Type:	Wall Mount (On Wall)
Chilling Capacity:	Non-refrigerated
Dimensions (L x W x H):	18" x 14-1/2" x 29-1/2"
Approx. Shipping Weight:	44 lbs.
Installation Location:	Indoor
No. of Stations Served:	1

- Mechanically-Activated bubbler continues to supply water in event of service disruptions.

Included with Product: Water Cooler
Ships in one box.

AMERICAN PRIDE. A LIFETIME TRADITION. Like your family, the Elkay family has values and traditions that endure. For almost a century, Elkay has been a family-owned and operated company, providing thousands of jobs that support our families and communities.



PRODUCT COMPLIANCE

ASME A112.19.3/CSA B45.4
Buy American Act
NSF/ANSI 61 & 372 (lead free)



[Installation Instructions \(PDF\)](#)





Water Systems are warranted for 12 months from date of installation. **Warranty pertains to drinking water applications only. Non-drinking water applications are not covered under warranty.**

[Warranty \(PDF\)](#)

PART: _____ QTY: _____
 PROJECT: _____
 CONTACT: _____
 DATE: _____
 NOTES: _____
 APPROVAL: _____

Optional Accessories

In keeping with our policy of continuing product improvement, Elkay reserves the right to change product specifications without notice. Please visit elkay.com for the most current version of Elkay product specification sheets. This specification describes an Elkay product with design, quality, and functional benefits to the user. When making a comparison of other producers' offerings, be certain these features are not overlooked.

EWF172	Elkay WaterSentry VII Filter Kit (Coolers + Fountains) Spec Sheet (PDF)	
LK1110	Elkay Glass Filler Spec Sheet (PDF)	
LK1114	Elkay Glass Filler Chrome 2-1/2" x 10" Spec Sheet (PDF)	
97446C	Accessory - Bubbler Kit Vandal-Resistant Spec Sheet (PDF)	

In keeping with our policy of continuing product improvement, Elkay reserves the right to change product specifications without notice. Please visit elkay.com for the most current version of Elkay product specification sheets. This specification describes an Elkay product with design, quality, and functional benefits to the user. When making a comparison of other producers' offerings, be certain these features are not overlooked.

Open space rough-in design permits new installation or replacement of existing fountains and coolers with this Elkay cooler when rough-in is within the outline shown.

IMPORTANT! INSTALLER PLEASE NOTE:

This water cooler has been designed and built to provide water to the user which has not been altered by materials in the cooler waterways.

NOTICE

The water cooler must be connected to the water supply using a dielectric coupling. The cooler is furnished with a non-metallic strainer which meets this requirement. The drain trap which is provided by the installer should also be plastic to completely isolate the cooler from the building plumbing system. These products are designed to operate on 20 psi to 105 psi supply line pressure.

OPERATION OF QUICK CONNECT FITTINGS

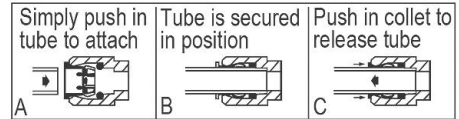

Pushing tube in before pulling it out helps to release tube

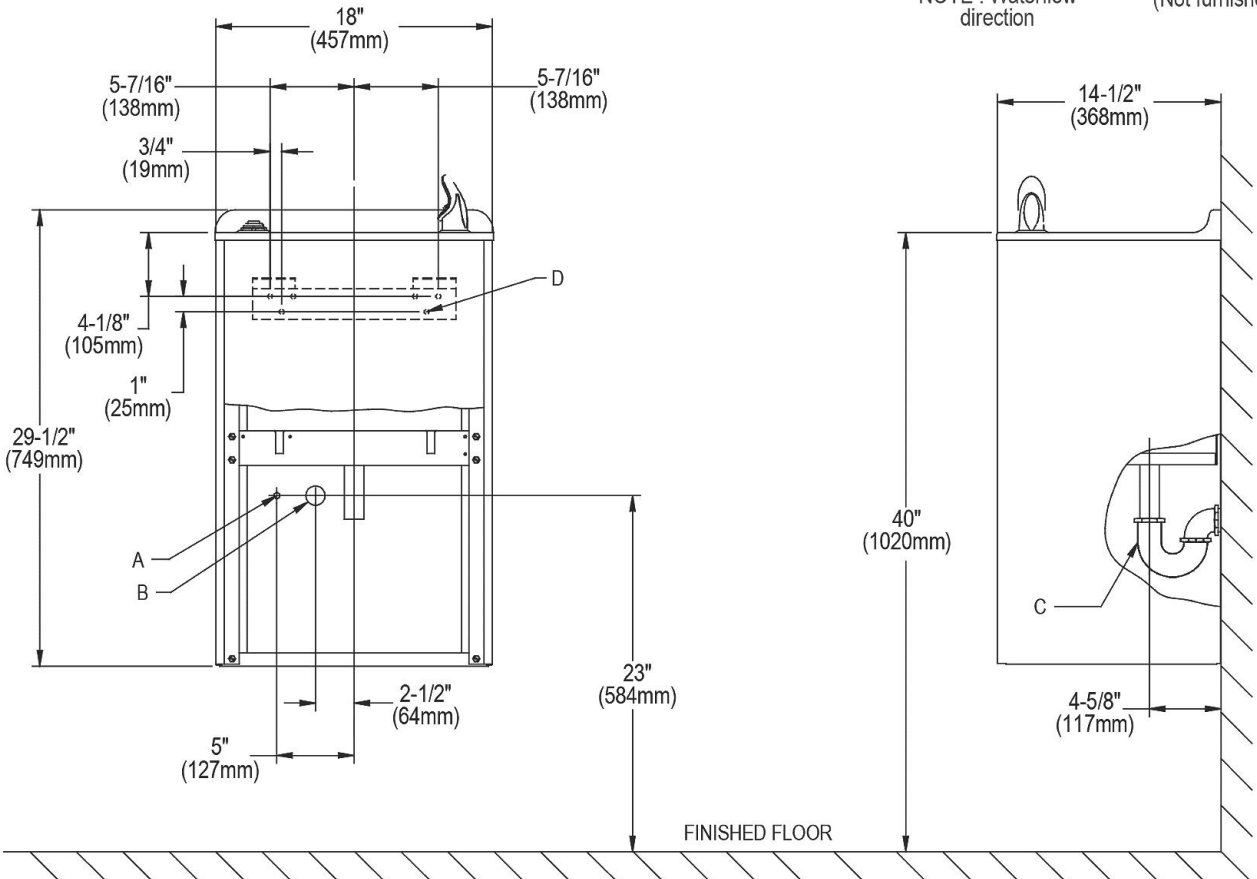
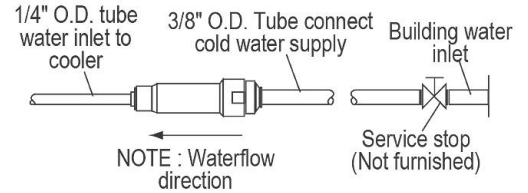

LEGEND

- A = Recommended water supply location 3/8" O.D. unplated copper tube connect stub out 1-1/2" (38mm) out from wall shut off by others.
- B = Recommended location for waste outlet 1-1/4" O.D. drain.
- C = 1-1/4" Trap not furnished.
- D = 5/16" (8mm) screw holes in mounting plate.

NOTE: New installations must use Ground Fault Circuit Interrupter (GFCI). It is highly recommended that the circuit be dedicated and the load protection be sized for 20 amps.

In keeping with our policy of continuing product improvement, Elkay reserves the right to change product specifications without notice. Please visit elkay.com for the most current version of Elkay product specification sheets. This specification describes an Elkay product with design, quality, and functional benefits to the user. When making a comparison of other producers' offerings, be certain these features are not overlooked.