

**PRODUCT SPECIFICATIONS**

Elkay Stainless Steel 60" x 20" x 8" Wall Hung Multiple Station Hand Wash Sink Kit. Sink is manufactured from 14 gauge 304 Stainless Steel with a Buffed Satin finish, Center drain placement.

<b>Material:</b>	304 Stainless Steel
<b>Finish:</b>	Buffed Satin
<b>Gauge:</b>	14
<b>Number of Bowls:</b>	1
<b>Sink Dimensions:</b>	60" x 20" x 25-3/4"
<b>Bowl 1 Dimensions:</b>	57" x 16-1/2" x 8"
<b>Drain Size:</b>	3-1/2" (89mm)
<b>Drain Location:</b>	Center



**Hole Drilling Configurations:**

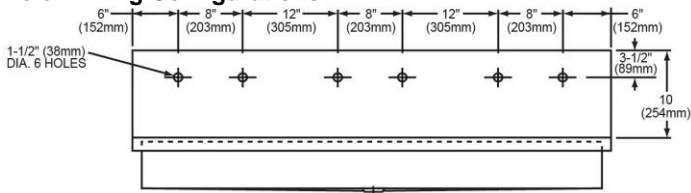

**Included with Product:** EWMA6020 sink, three LK940GN05T4H faucets, one LK18B drain

**Ships in multiple boxes.**

A Century of Tradition and Quality. For more than 100 years, Elkay has been making innovative products and providing exceptional customer care. We take pride in offering plumbing products that make life easier, inspire change and leave the world a better place.



**Product Compliance:** ASME A112.19.3/CSA B45.4  
**Faucet:** ADA & ICC A117.1  
 ASME A112.18.1/CSA B125.1  
 CEC  
 NSF 372 (lead free)  
 NSF 61  
**Accessory:** ASME A112.18.2/CSA B125.2

 Sinks are listed by IAPMO<sup>®</sup> as meeting the applicable requirements of the Uniform Plumbing Code<sup>®</sup>, International Plumbing Code<sup>®</sup>, and National Plumbing Code of Canada.

 Faucet complies with ADA & ICC A117.1 accessibility requirements when installed according to the requirements outlined in these standards.

[Clean and Care Manual \(PDF\)](#)  
[Installation Instructions \(PDF\) - 200000714](#)  
[Warranty \(PDF\)](#)

PART: \_\_\_\_\_ QTY: \_\_\_\_\_  
 PROJECT: \_\_\_\_\_  
 CONTACT: \_\_\_\_\_  
 DATE: \_\_\_\_\_  
 NOTES: \_\_\_\_\_  
 APPROVAL: \_\_\_\_\_

*In keeping with our policy of continuing product improvement, Elkay reserves the right to change product specifications without notice. Please visit [elkay.com](http://elkay.com) for the most current version of Elkay product specification sheets. This specification describes an Elkay product with design, quality, and functional benefits to the user. When making a comparison of other producers' offerings, be certain these features are not overlooked.*

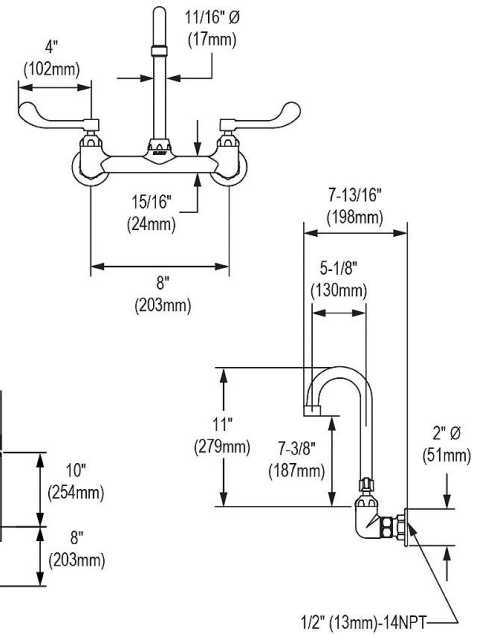
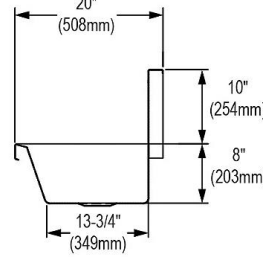
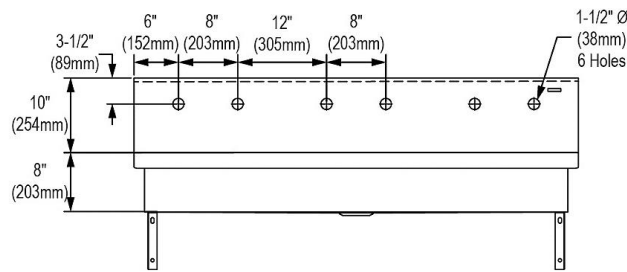
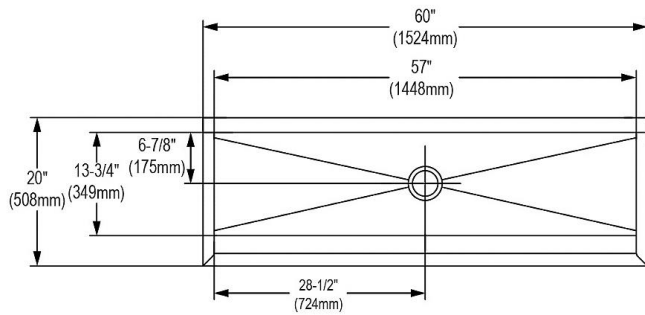

In keeping with our policy of continuing product improvement, Elkay reserves the right to change product specifications without notice. Please visit [elkay.com](http://elkay.com) for the most current version of Elkay product specification sheets. This specification describes an Elkay product with design, quality, and functional benefits to the user. When making a comparison of other producers' offerings, be certain these features are not overlooked.

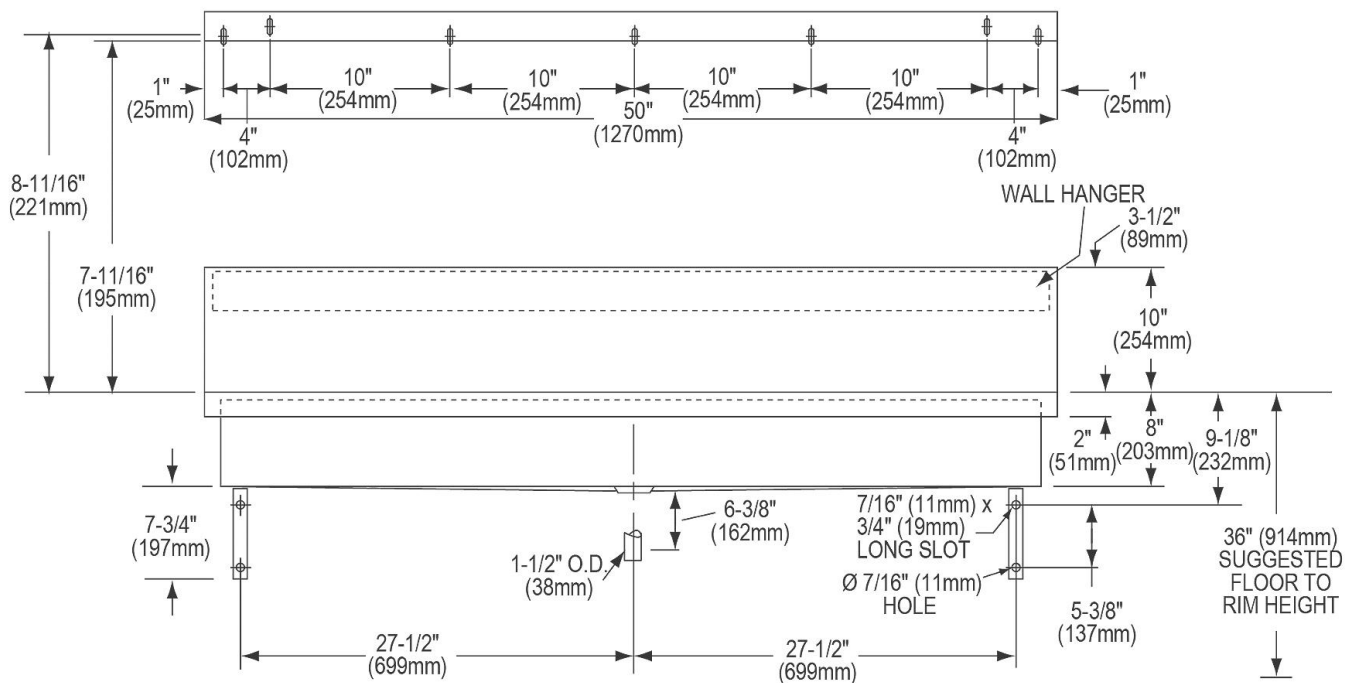

In keeping with our policy of continuing product improvement, Elkay reserves the right to change product specifications without notice. Please visit [elkay.com](http://elkay.com) for the most current version of Elkay product specification sheets. This specification describes an Elkay product with design, quality, and functional benefits to the user. When making a comparison of other producers' offerings, be certain these features are not overlooked.