

**PRODUCT SPECIFICATIONS**

Elkay Sturdibilt Stainless Steel 96" x 27-1/2" x 14" Floor Mount Double Compartment Scullery Sink with Drainboard. Sink is manufactured from 14 gauge 304 Stainless Steel with a Buffed Satin finish, Center drain placement. Sinks supported by (4) 16 gauge stainless steel, 1-5/8" O.D. tubular legs with bullet shaped feet adjustable up to 1".

<b>Material:</b>	304 Stainless Steel
<b>Special Features:</b>	Drainboard
<b>Finish:</b>	Buffed Satin
<b>Gauge:</b>	14
<b>Number of Bowls:</b>	2
<b>Sink Dimensions:</b>	96" x 27-1/2" x 44"
<b>Bowl 1 Dimensions:</b>	24" x 24" x 14"
<b>Bowl 2 Dimensions:</b>	24" x 24" x 14"
<b>Drainboard Location:</b>	Left and Right
<b>Drainboard Size:</b>	24
<b>Backsplash Height:</b>	8
<b>Leg Type:</b>	Stainless Steel
<b>Drain Size:</b>	3-1/2" (89mm)
<b>Drain Location:</b>	Center



A Century of Tradition and Quality. For more than 100 years, Elkay has been making innovative products and providing exceptional customer care. We take pride in offering plumbing products that make life easier, inspire change and leave the world a better place.



**Product Compliance:** ASME A112.19.3/CSA B45.4



Sinks are listed by IAPMO<sup>®</sup> as meeting the applicable requirements of the Uniform Plumbing Code<sup>®</sup>, International Plumbing Code<sup>®</sup>, and National Plumbing Code of Canada.

[Clean and Care Manual \(PDF\)](#)  
[Warranty \(PDF\)](#)

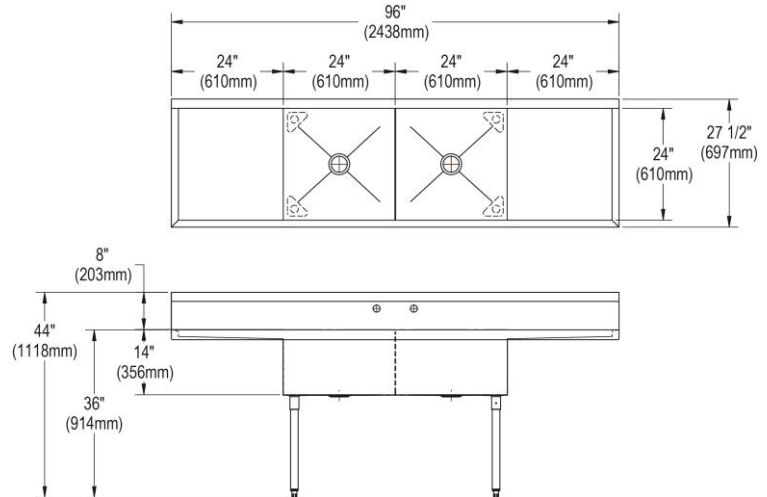

PART: \_\_\_\_\_ QTY: \_\_\_\_\_  
 PROJECT: \_\_\_\_\_  
 CONTACT: \_\_\_\_\_  
 DATE: \_\_\_\_\_  
 NOTES: \_\_\_\_\_  
 APPROVAL: \_\_\_\_\_

*In keeping with our policy of continuing product improvement, Elkay reserves the right to change product specifications without notice. Please visit [elkay.com](http://elkay.com) for the most current version of Elkay product specification sheets. This specification describes an Elkay product with design, quality, and functional benefits to the user. When making a comparison of other producers' offerings, be certain these features are not overlooked.*