

**PRODUCT SPECIFICATIONS**

Elkay Lustertone™ Classic Stainless Steel 36-1/4" x 21-1/8" x 10"  
60/40 Double Bowl Undermount Sink Kit. Sink is manufactured from 18  
gauge 304 Stainless Steel with a Lustrous Satin finish, Rear Center  
drain placement, and Sides and Bottom pads.

|                              |                                     |
|------------------------------|-------------------------------------|
| <b>Installation Type:</b>    | Sink Kits, Undermount               |
| <b>Material:</b>             | 304 Stainless Steel                 |
| <b>Finish:</b>               | Lustrous Satin                      |
| <b>Gauge:</b>                | 18                                  |
| <b>Sound Deadening:</b>      | Sides and Bottom pads               |
| <b>Number of Bowls:</b>      | 2                                   |
| <b>Sink Dimensions:</b>      | 36-1/4" x 21-1/8" x 10"             |
| <b>Bowl 1 Dimensions:</b>    | 21" x 18-5/8" x 10"                 |
| <b>Bowl 2 Dimensions:</b>    | 11-3/4" x 13-1/4" x 5-15/16"        |
| <b>Drain Size:</b>           | 3-1/2" (89mm)                       |
| <b>Drain Location:</b>       | Rear Center                         |
| <b>Minimum Cabinet Size:</b> | 42"                                 |
| <b>Mounting Hardware:</b>    | Undermount brackets sold separately |
| <b>Template Included:</b>    | Yes                                 |
| <b>Cutout Template #:</b>    | <a href="#">1000001533</a>          |

Template is available for download at [elkay.com](http://elkay.com). CAD software will be required to open the template.



**Included with Product:** one LKWOBG2118SS bottom grid,  
one LK99 drain

A Century of Tradition and Quality. For more than 100 years, Elkay has been making innovative products and providing exceptional customer care. We take pride in offering plumbing products that make life easier, inspire change and leave the world a better place.



**Product Compliance:** ASME A112.19.3/CSA B45.4  
**Accessory:** ASME A112.18.2/CSA B125.2

[Clean and Care Manual \(PDF\)](#)  
[Installation Instructions \(PDF\) - 1000005239](#)  
[Installation Instructions \(PDF\) - 1000005235\\_drain](#)  
[Warranty \(PDF\)](#)

**Similar models are available with:** small bowl on the opposite side

**Installation Profile:**

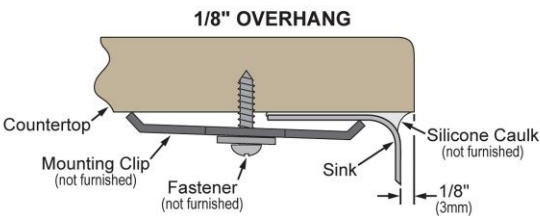
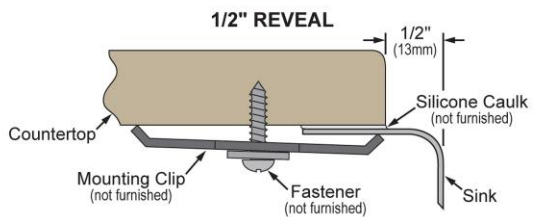



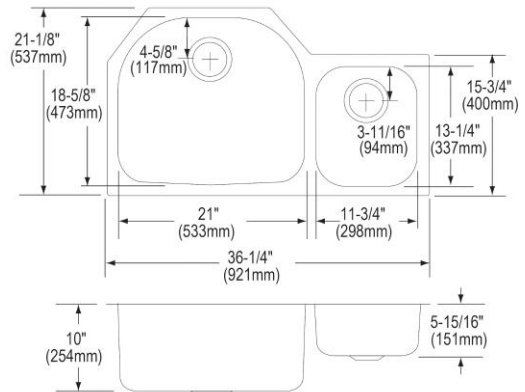

Designed to affix to the underside of any solid surface countertop.



PART: \_\_\_\_\_ QTY: \_\_\_\_\_  
PROJECT: \_\_\_\_\_  
CONTACT: \_\_\_\_\_  
DATE: \_\_\_\_\_  
NOTES: \_\_\_\_\_  
APPROVAL: \_\_\_\_\_

**Included Accessories**

In keeping with our policy of continuing product improvement, Elkay reserves the right to change product specifications without notice. Please visit [elkay.com](http://elkay.com) for the most current version of Elkay product specification sheets. This specification describes an Elkay product with design, quality, and functional benefits to the user. When making a comparison of other producers' offerings, be certain these features are not overlooked.

|                              |   |   |
|------------------------------|---|---|
| <a href="#">LK99</a>         | Elkay Deluxe 3-1/2" Drain Type 304 Stainless Steel Body Strainer Basket Rubber Seal and Tailpiece<br><a href="#">Spec Sheet (PDF)</a> |  |
| <a href="#">LKWOBG1616SS</a> | Elkay Stainless Steel 15" x 15" x 1" Bottom Grid<br><a href="#">Spec Sheet (PDF)</a>  |  |
| Optional Accessories         |   |   |
| <a href="#">LKWOBG1113SS</a> | Elkay Stainless Steel 10" x 12" x 1" Bottom Grid<br><a href="#">Spec Sheet (PDF)</a>  |  |
| <a href="#">CB2213</a>       | Elkay Hardwood 21-13/16" x 19-1/4" x 3/4" Cutting Board<br><a href="#">Spec Sheet (PDF)</a>   |  |

*In keeping with our policy of continuing product improvement, Elkay reserves the right to change product specifications without notice. Please visit [elkay.com](http://elkay.com) for the most current version of Elkay product specification sheets. This specification describes an Elkay product with design, quality, and functional benefits to the user. When making a comparison of other producers' offerings, be certain these features are not overlooked.*