

**PRODUCT SPECIFICATIONS**

Elkay Space-ette Cooler Floor Model Non-Filtered Refrigerated 3 GPH, Stainless. Chilling Capacity of 3.0 GPH (gallons per hour) of 50° F drinking water, based on 80° F inlet water and 90° F ambient, per ASHRAE 18 testing. Features shall include Glass Filler Prepped. Furnished with Flexi-Guard® Safety Bubbler. Mechanical Top Bubbler Button activation. Product shall be Floor Mount/Freestanding, for Indoor applications, serving 1 station(s). Unit shall be certified to UL 399 and CAN/CSA C22.2 No. 120. Unit shall be lead-free design which is certified to NSF/ANSI 61 & 372 (lead free) and meets Federal and State low-lead requirements.



<b>Special Features:</b>	Glass Filler Prepped
<b>Finish:</b>	Stainless Steel
<b>Power:</b>	115V/60Hz
<b>Bubbler Style:</b>	Flexi-Guard® Safety Bubbler
<b>Activation by:</b>	Mechanical Top Bubbler Button
<b>Mounting Type:</b>	Floor Mount/Freestanding
<b>Chilling Capacity*:</b>	3.0 GPH
<b>Full Load Amps</b>	3.5
<b>Rated Watts:</b>	230
<b>Dimensions (L x W x H):</b>	12" x 12" x 38"
<b>Approx. Shipping Weight:</b>	55 lbs.
<b>Installation Location:</b>	Indoor
<b>No. of Stations Served:</b>	1

\*Based on 80° F inlet water & 90° F ambient air temp for 50° F chilled drinking water.

**Special Note: Glass filler ordered separately.**

- Mechanically-Activated bubbler continues to supply water in event of service disruptions.

**COOLING SYSTEM**

- Compressor: Hermetically-sealed, reciprocating type, single phase. Sealed-in lifetime lubrication.
- Condenser: Fan cooled, copper tube with aluminum fins. Fan motor is permanently lubricated.
- Cooling Unit: Combination tube-tank type. Continuous copper tubing with is fully insulated with EPS foam that meets UL requirements for self-extinguishing material.
- Refrigerant Control: Refrigerant R-134a is controlled by accurately calibrated capillary tube.
- Temperature Control: Easily accessible enclosed adjustable thermostat is factory preset. Requires no adjustment other than for altitude requirements.

**Included with Product: Water Cooler**  
**Ships in one box.**

**AMERICAN PRIDE. A LIFETIME TRADITION.**  
Like your family, the Elkay family has values and traditions that endure. For almost a century, Elkay has been a family-owned and operated company, providing thousands of jobs that support our families and communities.



**PRODUCT COMPLIANCE**

ASME A112.19.3/CSA B45.4  
Buy American Act  
CAN/CSA C22.2 No. 120  
NSF/ANSI 61 & 372 (lead free)  
UL 399







[Installation Instructions \(PDF\)](#)

**5 Year Limited Warranty** on the refrigeration system of the unit. Electrical components and water system are warranted for 12 months from date of installation. **Warranty pertains to drinking water applications only. Non-drinking water applications are not covered under warranty.**

[Warranty \(PDF\)](#)

PART: \_\_\_\_\_ QTY: \_\_\_\_\_  
PROJECT: \_\_\_\_\_  
CONTACT: \_\_\_\_\_  
DATE: \_\_\_\_\_  
NOTES: \_\_\_\_\_  
APPROVAL: \_\_\_\_\_

*In keeping with our policy of continuing product improvement, Elkay reserves the right to change product specifications without notice. Please visit elkay.com for the most current version of Elkay product specification sheets. This specification describes an Elkay product with design, quality, and functional benefits to the user. When making a comparison of other producers' offerings, be certain these features are not overlooked.*

Optional Accessories		
<a href="#">EWF172</a>	Elkay WaterSentry VII Filter Kit (Coolers + Fountains) <a href="#">Spec Sheet (PDF)</a>	
<a href="#">LK1110</a>	Elkay Glass Filler <a href="#">Spec Sheet (PDF)</a>	
<a href="#">LK1114</a>	Elkay Glass Filler Chrome 2-1/2" x 10" <a href="#">Spec Sheet (PDF)</a>	
<a href="#">97446C</a>	Accessory - Bubbler Kit Vandal-Resistant <a href="#">Spec Sheet (PDF)</a>	

*In keeping with our policy of continuing product improvement, Elkay reserves the right to change product specifications without notice. Please visit [elkay.com](http://elkay.com) for the most current version of Elkay product specification sheets. This specification describes an Elkay product with design, quality, and functional benefits to the user. When making a comparison of other producers' offerings, be certain these features are not overlooked.*

Open space rough-in design permits new installation or replacement of existing fountains and coolers with this Elkay cooler when rough-in is within the outline shown.

### IMPORTANT! INSTALLER PLEASE NOTE:

This water cooler has been designed and built to provide water to the user which has not been altered by materials in the cooler waterways.

The grounding of electrical equipment such as telephone, computers, etc to water lines is a common procedure. This grounding may be in the building or occur away from the building. This grounding can cause electrical feedback into a water cooler creating an electrolysis which creates a metallic taste or causes an increase in the metal content of the water. This condition is avoidable by installing the cooler using the proper materials as shown below.

### NOTICE

The water cooler must be connected to the water supply using a dielectric coupling. The cooler is furnished with a non-metallic strainer which meets this requirement. The drain trap which is provided by the installer should also be plastic to completely isolate the cooler from the building plumbing system. These products are designed to operate on 20 psi to 105 psi supply line pressure.

### OPERATION OF QUICK CONNECT FITTINGS

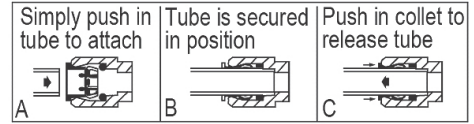

Pushing tube in before pulling it out helps to release tube

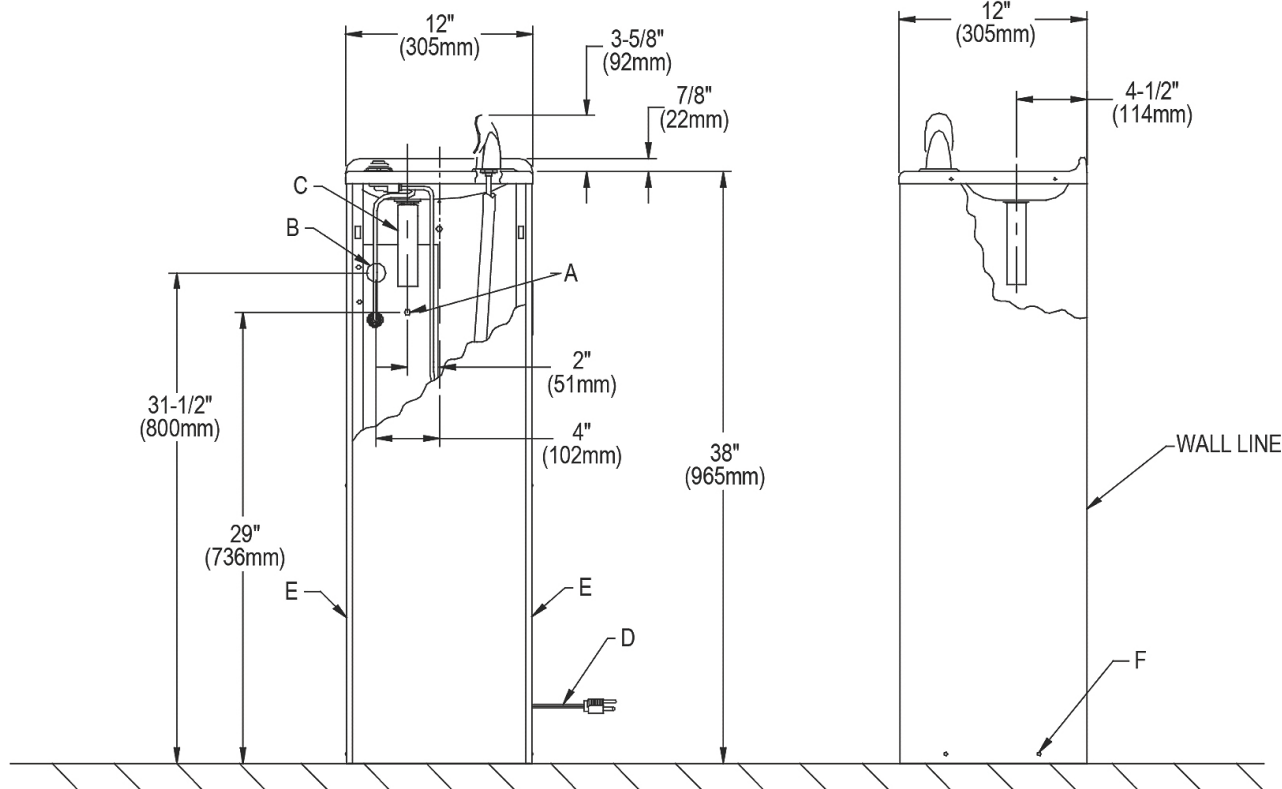
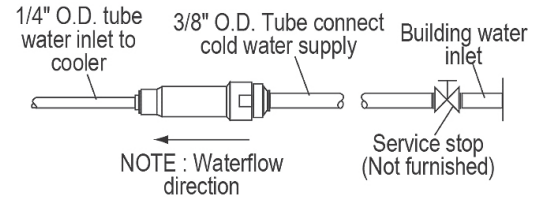

### LEGEND

A = Recommended water supply location. Shut off valve (not furnished) to accept 3/8" O.D. unplated copper tube connect.

B = Recommended location for waste outlet 1-1/4" O.D. drain.

C = 1-1/4" Trap (not furnished).

D = Power cord 4 feet (1219mm) long.

E = Insure proper ventilation by maintaining 4" (102mm) (MIN.) clearance from cabinet louvers to wall.

F = To level unit, loosen screws to adjust base for contact with floor. Tighten screws after unit has been leveled.

NOTE: New installations must use Ground Fault Circuit Interrupter (GFCI). It is highly recommended that the circuit be dedicated and the load protection be sized for 20 amps.

In keeping with our policy of continuing product improvement, Elkay reserves the right to change product specifications without notice. Please visit [elkay.com](http://elkay.com) for the most current version of Elkay product specification sheets. This specification describes an Elkay product with design, quality, and functional benefits to the user. When making a comparison of other producers' offerings, be certain these features are not overlooked.