

**PRODUCT SPECIFICATIONS**

Elkay Wall Mount Vandal Resistant ADA Cooler Filtered Non-refrigerated Stainless. Features shall include Filtered, Vandal Resistant. Furnished with Vandal Resistant bubbler. Mechanical Front Bubbler Button activation. Product shall be Wall Mount (On Wall), for Indoor applications, serving 1 station(s). Unit shall be lead-free design which is certified to NSF/ANSI 61 & 372 (lead free) and meets Federal and State low-lead requirements.



<b>Special Features:</b>	Filtered, Vandal Resistant
<b>Finish:</b>	Stainless Steel
<b>Power:</b>	No Electrical Required
<b>Bubbler Style:</b>	Vandal Resistant
<b>Activation by:</b>	Mechanical Front Bubbler Button
<b>Mounting Type:</b>	Wall Mount (On Wall)
<b>Chilling Capacity:</b>	Non-refrigerated
<b>Dimensions (L x W x H):</b>	18-1/16" x 18-5/8" x 20-5/8"
<b>Approx. Shipping Weight:</b>	39 lbs.
<b>Installation Location:</b>	Indoor
<b>No. of Stations Served:</b>	1

- Mechanically-Activated bubbler continues to supply water in event of service disruptions.
- Filter is certified to NSF 42 and 53 for lead, particulate, chlorine, taste and odor reduction. 1,500 gal. capacity.

**Included with Product:** Water Cooler, Filter

**Ships in one box.**

AMERICAN PRIDE. A LIFETIME TRADITION. Like your family, the Elkay family has values and traditions that endure. For almost a century, Elkay has been a family-owned and operated company, providing thousands of jobs that support our families and communities.



**PRODUCT COMPLIANCE**

- ADA & ICC A117.1
- ASME A112.19.3/CSA B45.4
- Buy American Act
- NSF/ANSI 42, 53, 61, & 372 (lead free)



Complies with ADA & ICC A117.1 accessibility requirements when installed according to the requirements outlined in these standards. Installation may require additional components and/or construction features to be fully compliant. Consult the local Authority Having Jurisdiction if necessary.

[Installation Instructions \(PDF\)](#)

Water Systems are warranted for 12 months from date of installation. **Warranty pertains to drinking water applications only. Non-drinking water applications are not covered under warranty.**

[Warranty \(PDF\)](#)

PART: \_\_\_\_\_ QTY: \_\_\_\_\_

PROJECT: \_\_\_\_\_





CONTACT: \_\_\_\_\_

DATE: \_\_\_\_\_

NOTES: \_\_\_\_\_

APPROVAL: \_\_\_\_\_

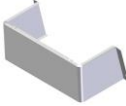
*In keeping with our policy of continuing product improvement, Elkay reserves the right to change product specifications without notice. Please visit [elkay.com](http://elkay.com) for the most current version of Elkay product specification sheets. This specification describes an Elkay product with design, quality, and functional benefits to the user. When making a comparison of other producers' offerings, be certain these features are not overlooked.*

Optional Accessories		
<a href="#">51299C</a>	Elkay WaterSentry VII Replacement Filter (Coolers + Fountains) <a href="#">Spec Sheet (PDF)</a>	
<a href="#">MLP100</a>	In-wall Carrier for Single-station On-wall Bottle Fillers, Coolers & Fountains <a href="#">Spec Sheet (PDF)</a>	
<a href="#">98324C</a>	Accessory - Cane Apron for HAC HVR EMABF & VRC Models (Stainless) <a href="#">Spec Sheet (PDF)</a>	
<a href="#">98481C</a>	Accessory - Bubbler Kit Water-Efficient Vandal-Resistant <a href="#">Spec Sheet (PDF)</a>	

*In keeping with our policy of continuing product improvement, Elkay reserves the right to change product specifications without notice. Please visit [elkay.com](http://elkay.com) for the most current version of Elkay product specification sheets. This specification describes an Elkay product with design, quality, and functional benefits to the user. When making a comparison of other producers' offerings, be certain these features are not overlooked.*

### IMPORTANT! INSTALLER PLEASE NOTE:

These units are designed and built to provide water to the user which has not been altered by materials in the cooler waterway. The grounding of electrical equipment such as telephone, computers, etc. to water lines is a common procedure. This grounding may be in the building but may also occur away from the building. This grounding can cause electrical feedback into a water cooler creating an electrolysis which results in a metallic taste or an increase in the metal content of the water. This condition is avoidable by installing the cooler using the proper materials as shown.

### NOTICE:

This water cooler must be connected to the water supply using a dielectric coupling. The cooler is furnished with a non-metallic strainer which meets this requirement. The drain trap which is provided by the installer should also be plastic to completely isolate the cooler from the building plumbing system. These products are designed to operate on 20 psi to 105 psi supply line pressure.

### OPERATION OF QUICK CONNECT FITTINGS

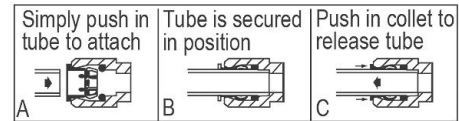

Pushing tube in before pulling it out helps to release tube

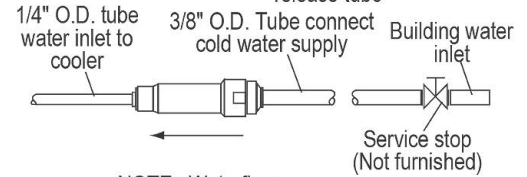

NOTE: Waterflow direction

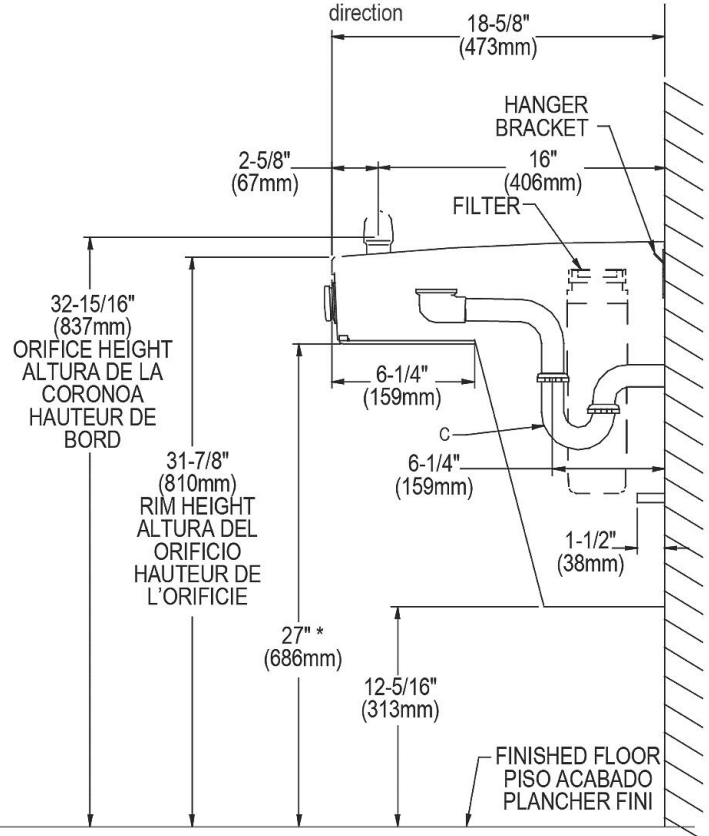
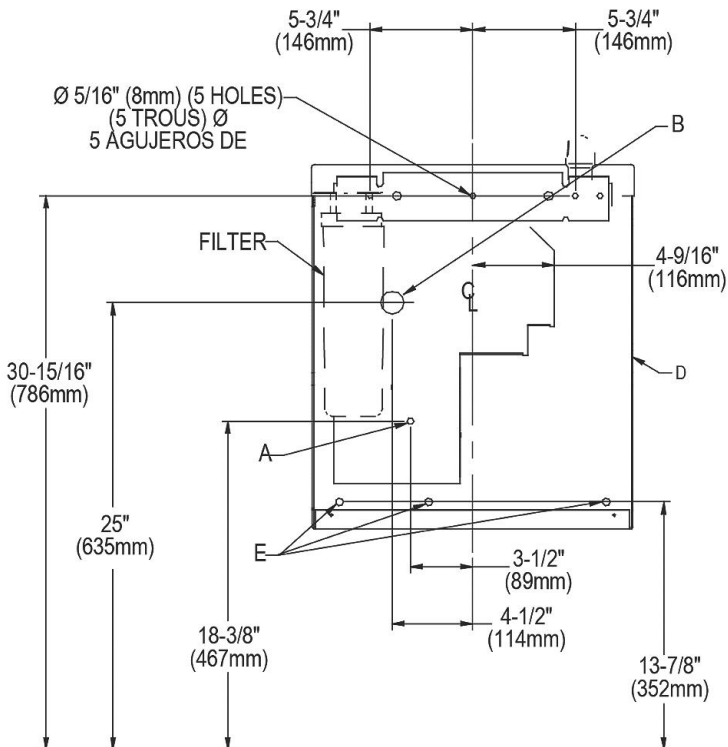

REDUCE HEIGHT BY 3" FOR INSTALLATION OF CHILDREN'S ADA COOLER

### LEGEND:

- A = Recommended Water Supply location. Shut-off Valve (not furnished) to accept 3/8" O.D. unplated copper tube. Up to 3" (38mm) maximum out from wall.
- B = Recommended Waste Outlet location. To accommodate 1-1/4" nominal drain. Drain stub 2" (51mm) out from wall.
- C = 1-1/4" Trap (not furnished).
- D = Insure proper ventilation by maintaining 6" (152mm) minimum clearance from cabinet louvers to wall.
- E = 7/16" (11mm) Bolt Holes for fastening to wall.

In keeping with our policy of continuing product improvement, Elkay reserves the right to change product specifications without notice. Please visit [elkay.com](http://elkay.com) for the most current version of Elkay product specification sheets. This specification describes an Elkay product with design, quality, and functional benefits to the user. When making a comparison of other producers' offerings, be certain these features are not overlooked.