

PRODUCT SPECIFICATIONS

Elkay Crosstown® 18 Gauge Stainless Steel 25-1/2" x 18-1/2" x 9" Single Bowl Undermount Sink & Faucet Kit with Bottom Grid & Drain. Sink is manufactured from 18 gauge 304 Stainless Steel with a Polished Satin finish, Rear Right drain placement, and Full spray sides and bottom with Sides and Bottom pads.

Installation Type:	Undermount
Material:	304 Stainless Steel
Finish:	Polished Satin
Gauge:	18
Sound Deadening:	Full spray sides and bottom with Sides and Bottom pads
Number of Bowls:	1
Sink Dimensions:	25-1/2" x 18-1/2" x 9"
Bowl 1 Dimensions:	24" x 17" x 9"
Drain Size:	3-1/2" (89mm)
Drain Location:	Rear Right
Minimum Cabinet Size:	30"
Mounting Hardware:	Included
Template Included:	Yes
Cutout Template #:	1000001380

Template is available for download at [elkay.com](#). CAD software will be required to open the template.

Installation Profile:

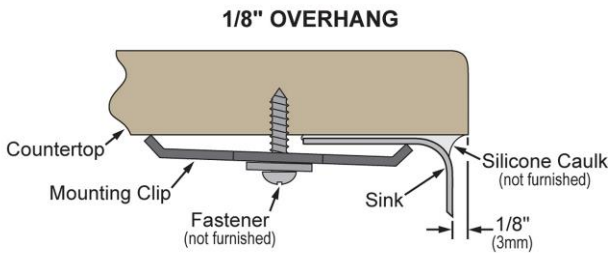

Designed to affix to the underside of any solid surface countertop.



Included with Product:

Custom fit bottom grid CTXBG2215, deep strainer drain LKDD and faucet LKAV3031CR

A Century of Tradition and Quality. For more than 100 years, Elkay has been making innovative products and providing exceptional customer care. We take pride in offering plumbing products that make life easier, inspire change and leave the world a better place.



Product Compliance:

Faucet:

ASME A112.19.3/CSA B45.4
ASME A112.18.1/CSA B125.1
NSF 61
NSF 372 (lead free)

Accessory:

ASME A112.18.2/CSA B125.2

- [Clean and Care Manual \(PDF\)](#)
- [Installation Instructions \(PDF\) - 1000005239](#)
- [Installation Instructions \(PDF\) - 1000005235](#)
- [drain Warranty \(PDF\)](#)

PART: _____ QTY: _____

PROJECT: _____



CONTACT: _____

DATE: _____

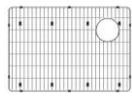

NOTES: _____

APPROVAL: _____

In keeping with our policy of continuing product improvement, Elkay reserves the right to change product specifications without notice. Please visit [elkay.com](#) for the most current version of Elkay product specification sheets. This specification describes an Elkay product with design, quality, and functional benefits to the user. When making a comparison of other producers' offerings, be certain these features are not overlooked.

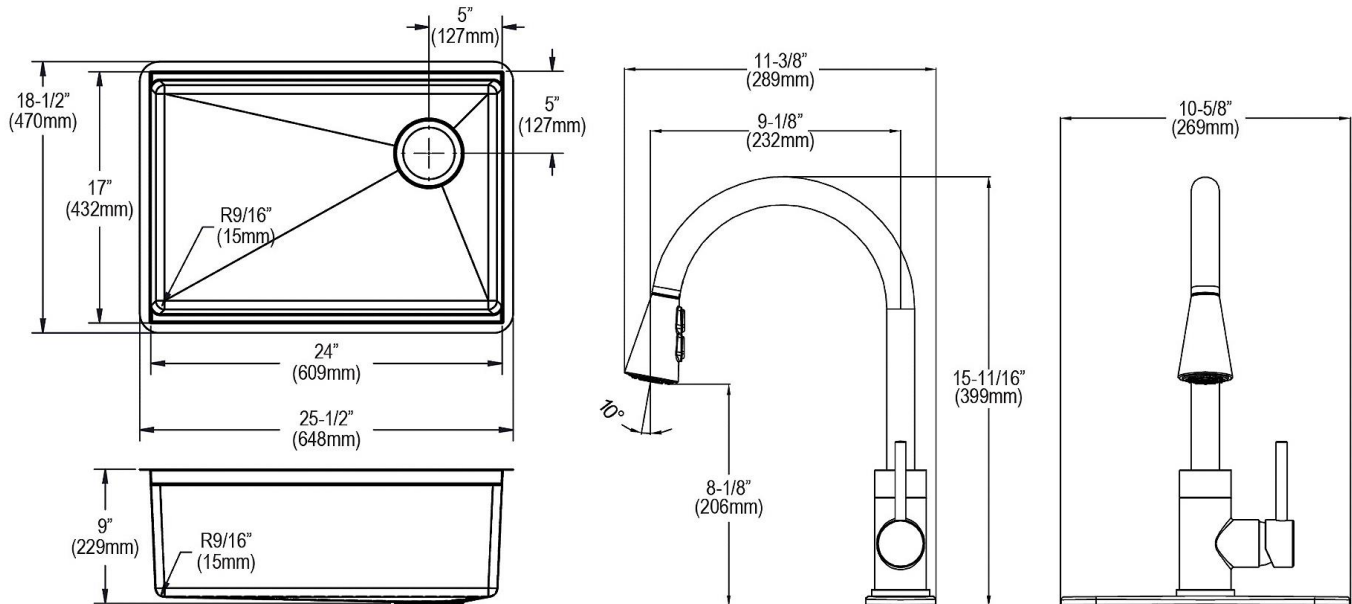
Included Accessories		
LKAV3031CR	Elkay Avado Single Hole Kitchen Faucet with Pull-down Spray and Forward Only Lever Handle Chrome Spec Sheet (PDF)	
CTXBG2215	Elkay Crosstown Stainless Steel 22-1/2" x 15-1/2" x 1-1/4" Bottom Grid Spec Sheet (PDF)	
LKDD	Elkay 3-1/2" Drain Fitting Deep Strainer Basket Spec Sheet (PDF)	



Optional Accessories		
CTXBG2215	Elkay Crosstown Stainless Steel 22-1/2" x 15-1/2" x 1-1/4" Bottom Grid Spec Sheet (PDF)	
LKDD	Elkay 3-1/2" Drain Fitting Deep Strainer Basket Spec Sheet (PDF)	
LKAV3031	Elkay Avado Single Hole Kitchen Faucet with Pull-down Spray and Forward Only Lever Handle Spec Sheet (PDF)	

In keeping with our policy of continuing product improvement, Elkay reserves the right to change product specifications without notice. Please visit elkay.com for the most current version of Elkay product specification sheets. This specification describes an Elkay product with design, quality, and functional benefits to the user. When making a comparison of other producers' offerings, be certain these features are not overlooked.