

PRODUCT SPECIFICATIONS

Elkay SwirlFlo® Bi-Level Reverse Fountain Non-Filtered, Non-Refrigerated Stainless. Furnished with Vandal Resistant bubbler. Mechanical Front Bubbler Button activation. Product shall be Wall Mount (On Wall), for Indoor + Outdoor applications, serving 2 station(s). Unit shall be lead-free design which is certified to NSF/ANSI 61 & 372 (lead free) and meets Federal and State low-lead requirements.

| | |
|---------------------------------|---------------------------------|
| Finish: | Stainless Steel |
| Power: | No Electrical Required |
| Bubbler Style: | Vandal Resistant |
| Activation by: | Mechanical Front Bubbler Button |
| Mounting Type: | Wall Mount (On Wall) |
| Chilling Capacity: | Non-refrigerated |
| Dimensions (L x W x H): | 38-1/2" x 19" x 21-15/16" |
| Approx. Shipping Weight: | 72 lbs. |
| Installation Location: | Indoor + Outdoor |
| No. of Stations Served: | 2 |

**When used in non-temperature controlled environments, unit(s) must be adequately winterized and/or protected from extreme heat to prevent damage where climates dictate.

- Mechanically-Activated bubbler continues to supply water in event of service disruptions.



Included with Product: Fountain with Back Plate, Surface Mounting

Ships in one box.

AMERICAN PRIDE. A LIFETIME TRADITION. Like your family, the Elkay family has values and traditions that endure. For almost a century, Elkay has been a family-owned and operated company, providing thousands of jobs that support our families and communities.



PRODUCT COMPLIANCE

- ADA & ICC A117.1
- ASME A112.19.3/CSA B45.4
- Buy American Act
- NSF/ANSI 61 & 372 (lead free)



Complies with ADA & ICC A117.1 accessibility requirements when installed according to the requirements outlined in these standards. Installation may require additional components and/or construction features to be fully compliant. Consult the local Authority Having Jurisdiction if necessary.

[Installation Instructions \(PDF\)](#)

Water Systems are warranted for 12 months from date of installation. **Warranty pertains to drinking water applications only. Non-drinking water applications are not covered under warranty.**

[Warranty \(PDF\)](#)

PART: _____ QTY: _____

PROJECT: _____



CONTACT: _____

DATE: _____

NOTES: _____

APPROVAL: _____

In keeping with our policy of continuing product improvement, Elkay reserves the right to change product specifications without notice. Please visit elkay.com for the most current version of Elkay product specification sheets. This specification describes an Elkay product with design, quality, and functional benefits to the user. When making a comparison of other producers' offerings, be certain these features are not overlooked.

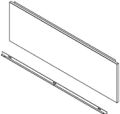
| Optional Accessories | | |
|-------------------------------|---|---|
| EWF172 | Elkay WaterSentry VII Filter Kit (Coolers + Fountains) Spec Sheet (PDF) |  |
| AP99 | Elkay Access Panel 9" x 9" x 6" Spec Sheet (PDF) |  |
| ACCESS12X38-5 | Accessory - Stainless Steel Access Panel for Bi-Level Architectural Fountains Spec Sheet (PDF) |  |

In keeping with our policy of continuing product improvement, Elkay reserves the right to change product specifications without notice. Please visit elkay.com for the most current version of Elkay product specification sheets. This specification describes an Elkay product with design, quality, and functional benefits to the user. When making a comparison of other producers' offerings, be certain these features are not overlooked.

INSTALLER NOTE

This drinking fountain is furnished with a bubbler and valve including all connecting fittings which are manufactured of completely lead free material. Shut off valve (not furnished) to accept 3/8" O.D. unplated copper tube.

These products are designed to operate on 20 psi to 105 psi supply line pressure. Simultaneous operation of both bubblers on a bi-level unit may not be possible depending on water supply pressure. If simultaneous operation is desired, please ensure a minimum of 50 psi supply.

OPERATION OF QUICK CONNECT FITTINGS

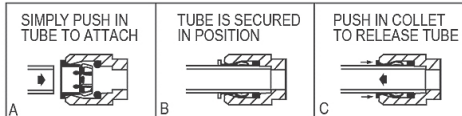

PUSHING TUBE IN BEFORE PULLING IT OUT HELPS TO RELEASE TUBE

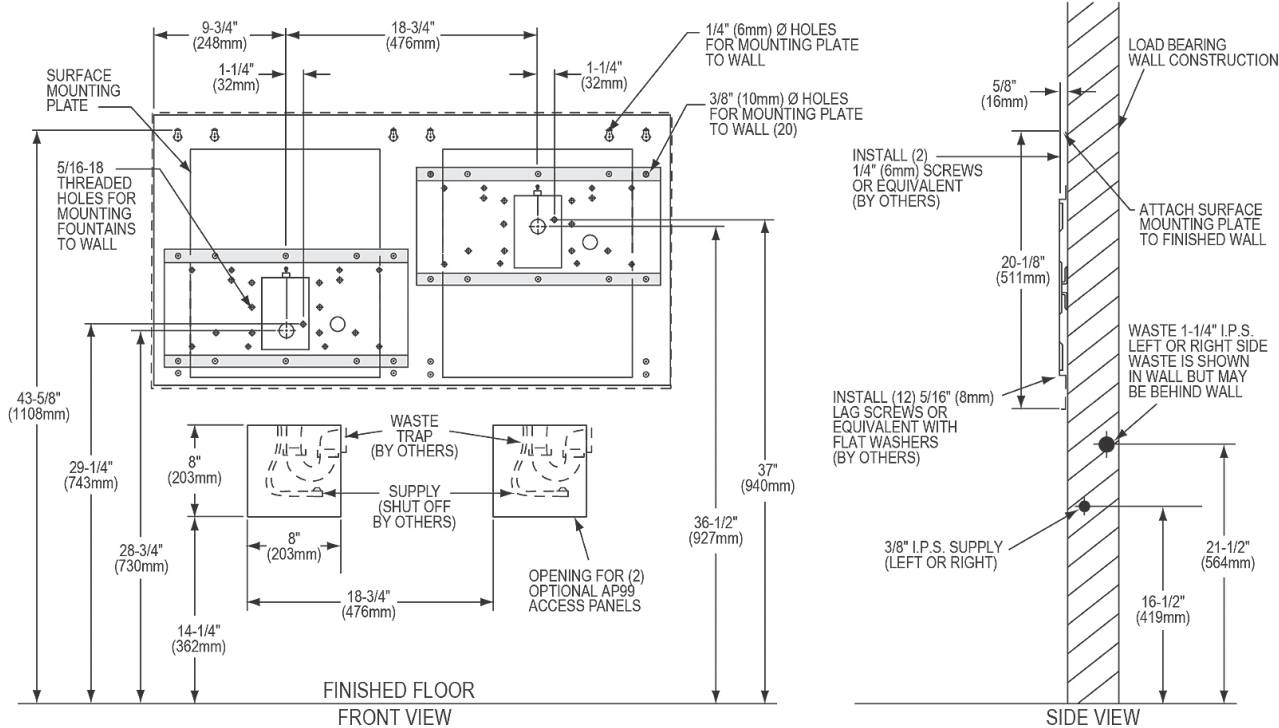
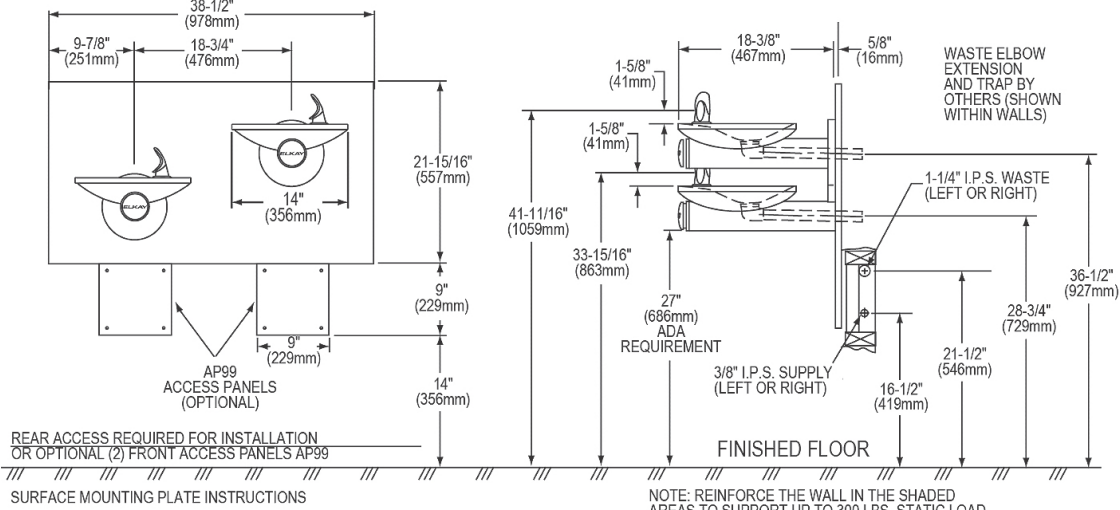
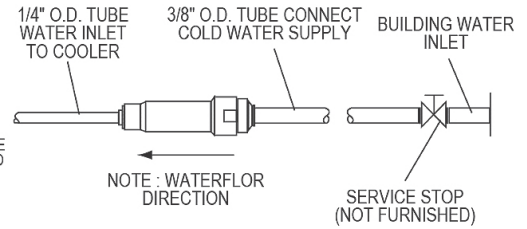

In keeping with our policy of continuing product improvement, Elkay reserves the right to change product specifications without notice. Please visit elkay.com for the most current version of Elkay product specification sheets. This specification describes an Elkay product with design, quality, and functional benefits to the user. When making a comparison of other producers' offerings, be certain these features are not overlooked.