

**PRODUCT SPECIFICATIONS**

Elkay Crosstown® 16 Gauge Stainless Steel 30-1/2" x 18-1/2" x 10" Single Bowl Undermount Sink Kit with Filtered Beverage Faucet. Sink is manufactured from 16 gauge 304 Stainless Steel with a Stainless Steel finish, Rear Center drain placement, and Full spray sides and bottom with Sides and Bottom pads.

<b>Installation Type:</b>	Undermount, Sink Kits
<b>Material:</b>	304 Stainless Steel
<b>Finish:</b>	Stainless Steel
<b>Gauge:</b>	16
<b>Sound Deadening:</b>	Full spray sides and bottom with Sides and Bottom pads
<b>Number of Bowls:</b>	1
<b>Sink Dimensions:</b>	30-1/2" x 18-1/2" x 10"
<b>Bowl 1 Dimensions:</b>	28" x 16" x 10"
<b>Drain Size:</b>	3-1/2" (89mm)
<b>Drain Location:</b>	Rear Center
<b>Minimum Cabinet Size:</b>	36"
<b>Mounting Hardware:</b>	Included
<b>Template Included:</b>	Yes
<b>Cutout Template #:</b>	<a href="#">1000001302</a>

Template is available for download at [elkay.com](#). CAD software will be required to open the template.

**Special Note:** Kitchen faucet sold separately

**Installation Profile:**

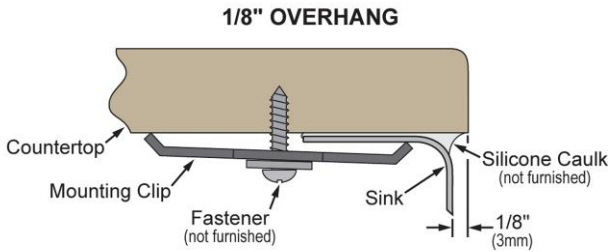

Designed to affix to the underside of any solid surface countertop.



**Included with Product:**

LKAV71FLS Beverage Faucet and Filter with EFRU281610T Sink, CTXBG2614 Bottom Grid, LKDD Deep Strainer Drain

A Century of Tradition and Quality. For more than 100 years, Elkay has been making innovative products and providing exceptional customer care. We take pride in offering plumbing products that make life easier, inspire change and leave the world a better place.



**Product Compliance:**

- Faucet: ASME A112.19.3/CSA B45.4  
ASME A112.18.1/CSA B125.1  
NSF 61  
NSF 372 (lead free)
- Accessory: ASME A112.18.2/CSA B125.2  
NSF 42  
NSF 53

- [Clean and Care Manual \(PDF\)](#)
- [Installation Instructions \(PDF\) - 1000005239](#)
- [Installation Instructions \(PDF\) - 1000005235 drain](#)
- [Installation Instructions \(PDF\) - Warranty \(PDF\)](#)

PART: \_\_\_\_\_ QTY: \_\_\_\_\_

PROJECT: \_\_\_\_\_



CONTACT: \_\_\_\_\_

DATE: \_\_\_\_\_

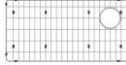

NOTES: \_\_\_\_\_

APPROVAL: \_\_\_\_\_

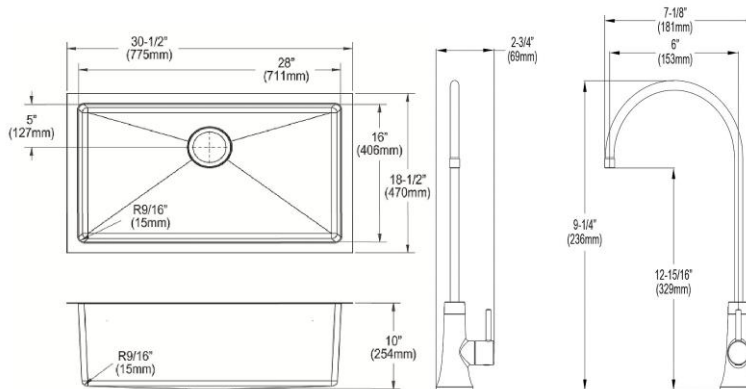

In keeping with our policy of continuing product improvement, Elkay reserves the right to change product specifications without notice. Please visit [elkay.com](#) for the most current version of Elkay product specification sheets. This specification describes an Elkay product with design, quality, and functional benefits to the user. When making a comparison of other producers' offerings, be certain these features are not overlooked.

Included Accessories		
<a href="#">LKDD</a>	Elkay 3-1/2" Drain Fitting Deep Strainer Basket <a href="#">Spec Sheet (PDF)</a>	
<a href="#">CTXBG2814</a>	Elkay Crosstown Stainless Steel 28-1/4" x 14-1/4" x 1-1/4" Bottom Grid <a href="#">Spec Sheet (PDF)</a>	
<a href="#">LKAV71FLS</a>	Elkay Avado Single Lever Filtered Beverage Faucet Lustrous Steel <a href="#">Spec Sheet (PDF)</a>	



Optional Accessories		
<a href="#">LK99</a>	Elkay Deluxe 3-1/2" Drain Type 304 Stainless Steel Body Strainer Basket Rubber Seal and Tailpiece <a href="#">Spec Sheet (PDF)</a>	
<a href="#">LKAV3031</a>	Elkay Avado Single Hole Kitchen Faucet with Pull-down Spray and Forward Only Lever Handle <a href="#">Spec Sheet (PDF)</a>	

In keeping with our policy of continuing product improvement, Elkay reserves the right to change product specifications without notice. Please visit [elkay.com](http://elkay.com) for the most current version of Elkay product specification sheets. This specification describes an Elkay product with design, quality, and functional benefits to the user. When making a comparison of other producers' offerings, be certain these features are not overlooked.

<a href="#">LKAV4061</a>	<p>Elkay Avado Single Hole Kitchen Faucet with Semi-professional Spout Forward Only Lever Handle</p> <p><a href="#">Spec Sheet (PDF)</a></p>	
<a href="#">LKEC2041</a>	<p>Elkay Explore Single Hole Kitchen Faucet with Pull-down Spray and Forward Only Lever Handle</p> <p><a href="#">Spec Sheet (PDF)</a></p>	
<a href="#">ERF750</a>	<p>Elkay 750-gallon Residential Replacement Filter</p> <p><a href="#">Spec Sheet (PDF)</a></p>	

*In keeping with our policy of continuing product improvement, Elkay reserves the right to change product specifications without notice. Please visit [elkay.com](http://elkay.com) for the most current version of Elkay product specification sheets. This specification describes an Elkay product with design, quality, and functional benefits to the user. When making a comparison of other producers' offerings, be certain these features are not overlooked.*