

**PRODUCT SPECIFICATIONS**

Elkay Crosstown® 16 Gauge Workstation Stainless Steel 31-1/2" x 18-1/2" x 9" Equal Double Bowl Sink Kit with Aqua Divide. Sink is manufactured from 16 gauge 304 Stainless Steel with a Polished Satin finish, Full spray sides and bottom with Sides and Bottom pads.

<b>Installation Type:</b>	Sink Kits, Undermount
<b>Material:</b>	304 Stainless Steel
<b>Special Features:</b>	Workstation
<b>Finish:</b>	Polished Satin
<b>Gauge:</b>	16
<b>Sound Deadening:</b>	Full spray sides and bottom with Sides and Bottom pads
<b>Number of Bowls:</b>	2
<b>Sink Dimensions:</b>	31-1/2" x 18-1/2" x 9"
<b>Bowl 1 Dimensions:</b>	14-5/16" x 17" x 9"
<b>Bowl 2 Dimensions:</b>	14-5/16" x 17" x 9"
<b>Drain Size:</b>	3-1/2" (89mm)
<b>Minimum Cabinet Size:</b>	36"
<b>Mounting Hardware:</b>	Part # 54300308 included
<b>Template Included:</b>	Yes
<b>Cutout Template #:</b>	<a href="#">1000005511</a>

Template is available for download at [elkay.com](http://elkay.com). CAD software will be required to open the template.

**Installation Profile:**

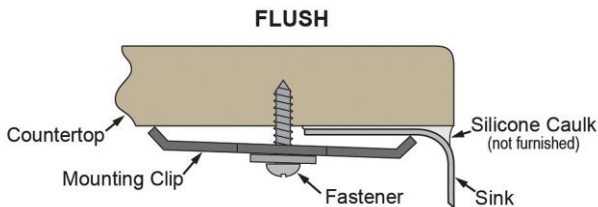

Designed to affix to the underside of any solid surface countertop.

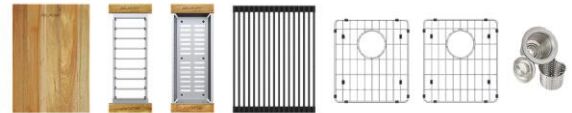

**Included with Product:** Two CTXBG1314 bottom grids, LKC0717SS colander, LKCB1217AC Cutting Board, LKDR1317RU drying rack, LKDR0717SS drying rack, two LKDD drains

A Century of Tradition and Quality. For more than 100 years, Elkay has been making innovative products and providing exceptional customer care. We take pride in offering plumbing products that make life easier, inspire change and leave the world a better place.



**Product Compliance:** ASME A112.19.3/CSA B45.4  
**Accessory:** ASME A112.18.2/CSA B125.2



Sinks are listed by IAPMO® as meeting the applicable requirements of the Uniform Plumbing Code®, International Plumbing Code®, and National Plumbing Code of Canada.



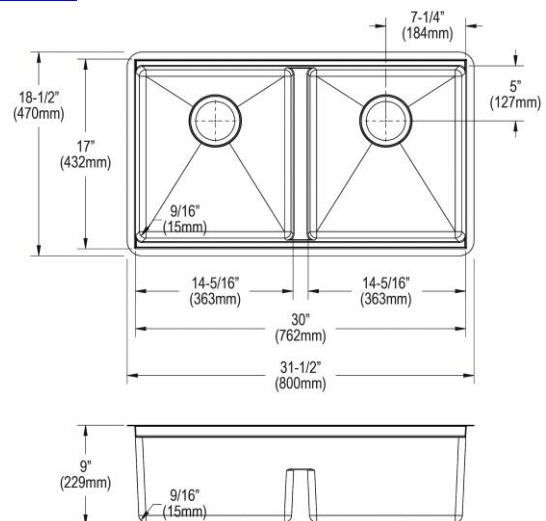

- [Clean and Care Manual \(PDF\)](#)
- [Installation Instructions \(PDF\) - 1000005239](#)
- [Installation Instructions \(PDF\) - 1000005235\\_drain](#)
- [Installation Instructions \(PDF\) - Warranty \(PDF\)](#)

PART: \_\_\_\_\_ QTY: \_\_\_\_\_  
 PROJECT: \_\_\_\_\_  
 CONTACT: \_\_\_\_\_  
 DATE: \_\_\_\_\_  
 NOTES: \_\_\_\_\_  
 APPROVAL: \_\_\_\_\_

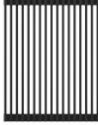

**Included Accessories**

In keeping with our policy of continuing product improvement, Elkay reserves the right to change product specifications without notice. Please visit [elkay.com](http://elkay.com) for the most current version of Elkay product specification sheets. This specification describes an Elkay product with design, quality, and functional benefits to the user. When making a comparison of other producers' offerings, be certain these features are not overlooked.

<a href="#">CTXBG1314</a>	<p>Elkay Crosstown Stainless Steel 12-3/4" x 14-1/4" x 1-1/4" Bottom Grid <a href="#">Spec Sheet (PDF)</a></p>	
<a href="#">LKC0717SS</a>	<p>Elkay Crosstown Stainless Steel 16-7/8" x 6-3/4" x 3-1/8" Colander with Wood Handles <a href="#">Spec Sheet (PDF)</a></p>	
<a href="#">LKCB1217AC</a>	<p>Elkay Acacia Hardwood 12" x 16-7/8" x 1" Cutting Board <a href="#">Spec Sheet (PDF)</a></p>	
<a href="#">LKDR1317RU</a>	<p>Elkay Crosstown Black Silicone 11-7/8" x 16-3/4" x 3/8" Drying Rack <a href="#">Spec Sheet (PDF)</a></p>	
<a href="#">LKDR0717SS</a>	<p>Elkay Crosstown Stainless Steel 16-7/8" x 6-3/4" x 4-1/4" Drying Rack with Wood Handles <a href="#">Spec Sheet (PDF)</a></p>	

*In keeping with our policy of continuing product improvement, Elkay reserves the right to change product specifications without notice. Please visit [elkay.com](http://elkay.com) for the most current version of Elkay product specification sheets. This specification describes an Elkay product with design, quality, and functional benefits to the user. When making a comparison of other producers' offerings, be certain these features are not overlooked.*