

PRODUCT SPECIFICATIONS

Elkay Quartz Classic® 33" x 22" x 10" Offset 60/40 Double Bowl Undermount Sink Kit with Filtered Faucet with Aqua Divide. Sink is molded with up to 80% natural quartz and high performance acrylic resins that are non-porous providing superior heat, scratch, fade and stain resistance. Naturally sound deadening and Rear Center drain placement.



Installation Type:	Sink Kits, Undermount
Material:	Quartz
Finish:	Black (BK), Greystone (GS), Mocha (MC), White (WH)
Number of Bowls:	2
Sink Dimensions:	33" x 22" x 10"
Bowl 1 Dimensions:	17-3/16" x 19-5/16" x 10"
Bowl 2 Dimensions:	13-1/8" x 16-5/8" x 1"
Drain Size:	3-1/2" (89mm)
Drain Location:	Rear Center
Minimum Cabinet Size:	36"
Mounting Hardware:	Included
Template Included:	Yes
Cutout Template #:	1000003465

Template is available for download at [elkay.com](#). CAD software will be required to open the template.

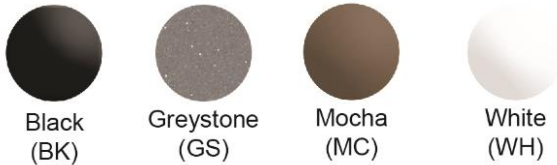

Included with Product:

LKAV7051FCR Faucet with filter included, LKQS35 Strainer, LKQD35 Flange, LKOBG1618SS Bottom Grid, LKOBG1115SS Bottom Grid

A Century of Tradition and Quality. For more than 100 years, Elkay has been making innovative products and providing exceptional customer care. We take pride in offering plumbing products that make life easier, inspire change and leave the world a better place.



Product Compliance:

Faucet:

CSA B45.5/IAPMO Z124
ASME A112.18.1/CSA B125.1
NSF 61
NSF 372 (lead free)

Accessory:

ASME A112.18.2/CSA B125.2
NSF 42
NSF 53
NSF 401

[Clean and Care Manual \(PDF\)](#)
[Installation Instructions \(PDF\) - 1000005238](#)
[Warranty \(PDF\)](#)

Installation Profile:

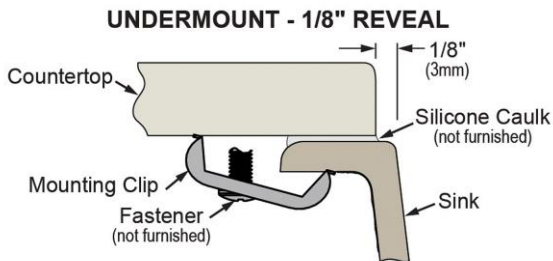

Designed to affix to the underside of any solid surface countertop.

PART: _____ QTY: _____

PROJECT: _____





CONTACT: _____

DATE: _____

NOTES: _____

APPROVAL: _____

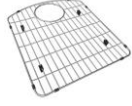



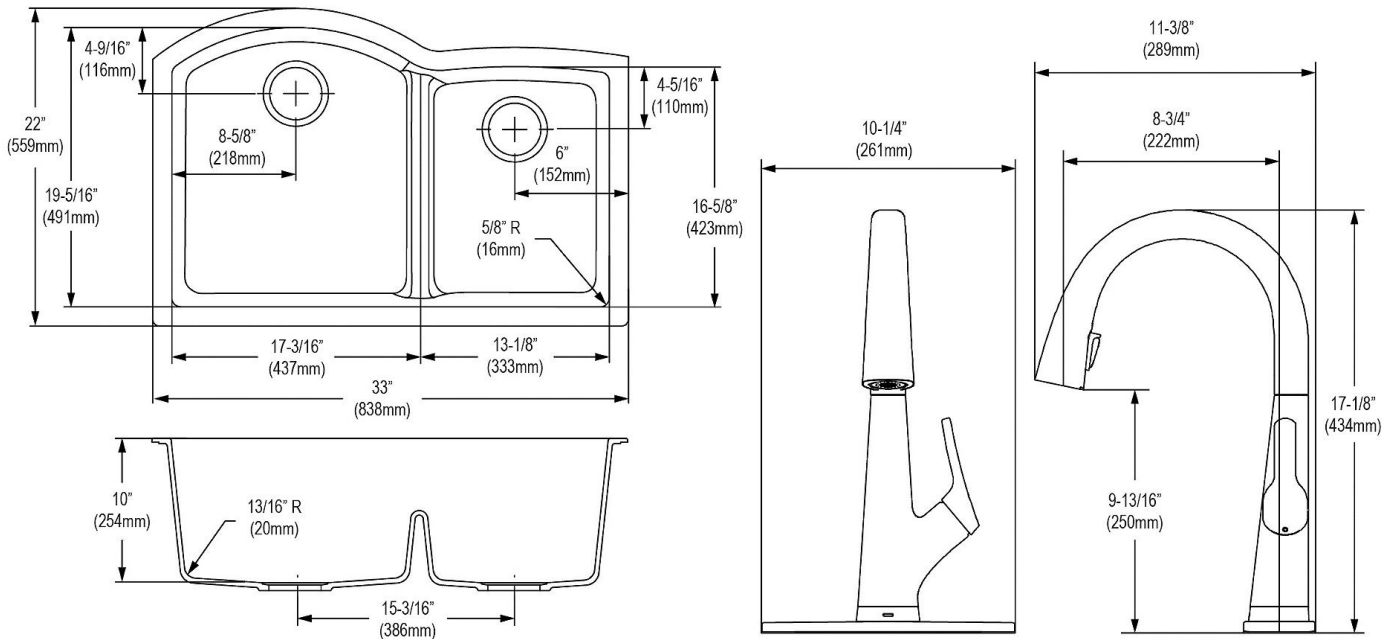

In keeping with our policy of continuing product improvement, Elkay reserves the right to change product specifications without notice. Please visit [elkay.com](#) for the most current version of Elkay product specification sheets. This specification describes an Elkay product with design, quality, and functional benefits to the user. When making a comparison of other producers' offerings, be certain these features are not overlooked.

Included Accessories		
LKOBG1115SS	Elkay® Stainless Steel 11" x 14-5/8" x 1" Bottom Grid Spec Sheet (PDF)	
LKAV7051FCR	Avado® Single Hole 2-in-1 Kitchen Faucet with Filtered Drinking Water Chrome Spec Sheet (PDF)	
LKOBG1618SS	Elkay® Stainless Steel 15-1/16" x 17-3/16" x 1" Bottom Grid Spec Sheet (PDF)	
LKQD35	Elkay® Polymer 3-1/2" Disposer Flange with Removable Basket Strainer and Rubber Stopper Spec Sheet (PDF)	
LKQS35	Elkay® Polymer 3-1/2" Drain Fitting with Removable Basket Strainer and Rubber Stopper Spec Sheet (PDF)	



Optional Accessories		
LKOBG1618SS	Elkay® Stainless Steel 15-1/16" x 17-3/16" x 1" Bottom Grid Spec Sheet (PDF)	

In keeping with our policy of continuing product improvement, Elkay reserves the right to change product specifications without notice. Please visit elkay.com for the most current version of Elkay product specification sheets. This specification describes an Elkay product with design, quality, and functional benefits to the user. When making a comparison of other producers' offerings, be certain these features are not overlooked.

LK99	Deluxe 3-1/2" Drain Type 304 Stainless Steel Body Strainer Basket Rubber Seal and Tailpiece Spec Sheet (PDF)	
LKQD35	Elkay® Polymer 3-1/2" Disposer Flange with Removable Basket Strainer and Rubber Stopper Spec Sheet (PDF)	
LKQS35	Elkay® Polymer 3-1/2" Drain Fitting with Removable Basket Strainer and Rubber Stopper Spec Sheet (PDF)	
LKWERBSS	Elkay® Stainless Steel 15-3/8" x 12-3/8" x 5-7/16" Rinsing Basket Spec Sheet (PDF)	
ERF750	WaterSentry® Lead + Microplastics NSF/ANSI Certified Residential Filter (ezH2O Liv & Filtered Faucet) Spec Sheet (PDF)	
LKQD35	Elkay® Polymer 3-1/2" Disposer Flange with Removable Basket Strainer and Rubber Stopper Spec Sheet (PDF)	
LKQS35	Elkay® Polymer 3-1/2" Drain Fitting with Removable Basket Strainer and Rubber Stopper Spec Sheet (PDF)	

In keeping with our policy of continuing product improvement, Elkay reserves the right to change product specifications without notice. Please visit elkay.com for the most current version of Elkay product specification sheets. This specification describes an Elkay product with design, quality, and functional benefits to the user. When making a comparison of other producers' offerings, be certain these features are not overlooked.