

PRODUCT SPECIFICATIONS

Elkay Quartz Classic 33" x 20-7/8" x 9-7/16" Single Bowl Drop-in Sink. Sink is molded with up to 80% natural quartz and high performance acrylic resins that are non-porous providing superior heat, scratch, fade and stain resistance. Naturally sound deadening and Rear Center drain placement.



Installation Type:	Drop-in
Material:	Quartz
Finish:	Black (BK), Dusk Gray (GY), Graphite (GT), Greystone (GS), Matte Black (MB), Mocha (MC), White (WH)
Number of Bowls:	1
Sink Dimensions:	33" x 20-7/8" x 9-7/16"
Bowl 1 Dimensions:	30-1/4" x 16-5/16" x 9-7/16"
Drain Size:	3-1/2" (89mm)
Drain Location:	Rear Center
Minimum Cabinet Size:	36"
Mounting Hardware:	Part # 64090408 included for countertops up to 1-3/4" (44mm) thick
Template Included:	No
Cutout Template #:	1000003473

Template is available for download at [elkay.com](#). CAD software will be required to open the template.

Cutout Dimensions for Drop-in Installation:

32-3/8" x 20-1/4" (822mm x 514mm) with 11/16" (17mm) corner radius

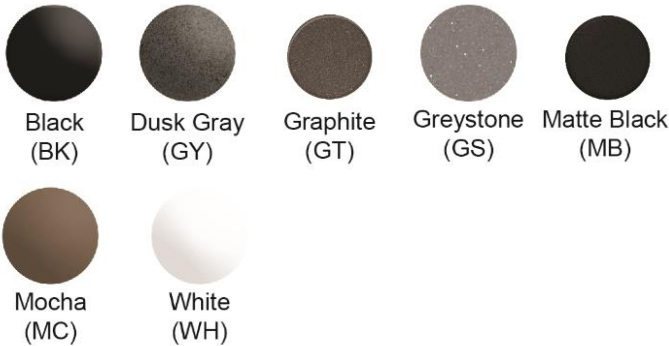

A Century of Tradition and Quality. For more than 100 years, Elkay has been making innovative products and providing exceptional customer care. We take pride in offering plumbing products that make life easier, inspire change and leave the world a better place.



Product Compliance: CSA B45.5/IAPMO Z124



Sinks are listed by IAPMO[®] as meeting the applicable requirements of the Uniform Plumbing Code[®], International Plumbing Code[®], and National Plumbing Code of Canada.

[Clean and Care Manual \(PDF\)](#)
[Installation Instructions \(PDF\) - 1000005238](#)
[Warranty \(PDF\)](#)

1-1/2" (38mm) Diameter Faucet Holes on 4" (102mm) Centers are Pre-Scored. Installer can punch up to 5 faucet holes.

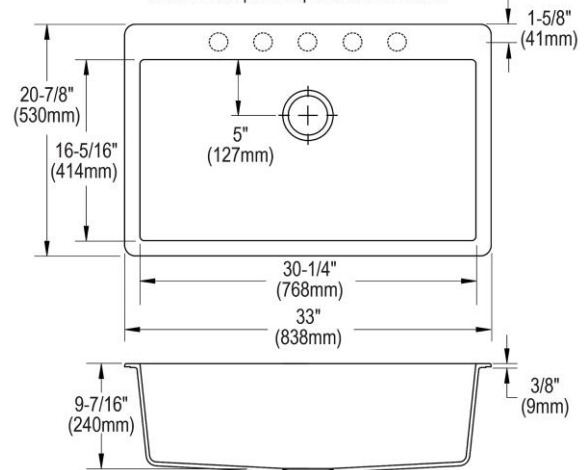

PART: _____ QTY: _____

PROJECT: _____

CONTACT: _____

DATE: _____

NOTES: _____





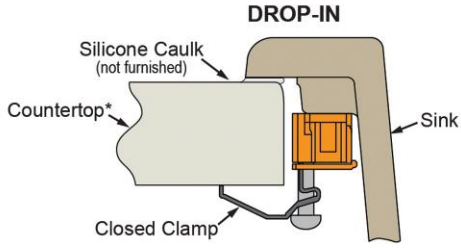

APPROVAL: _____

In keeping with our policy of continuing product improvement, Elkay reserves the right to change product specifications without notice. Please visit [elkay.com](#) for the most current version of Elkay product specification sheets. This specification describes an Elkay product with design, quality, and functional benefits to the user. When making a comparison of other producers' offerings, be certain these features are not overlooked.

Installation Profile:



*Maximum thickness for use of hold down system is 1-3/4" (44mm).

Optional Accessories		
LKOBG2915SS	Elkay Stainless Steel 27-1/2" x 13-1/2" x 1-1/4" Bottom Grid Spec Sheet (PDF)	
LK99	Elkay® Deluxe 3-1/2" Drain Type 304 Stainless Steel Body Strainer Basket Rubber Seal and Tailpiece Spec Sheet (PDF)	
LKQD35	Elkay® Polymer 3-1/2" Disposer Flange with Removable Basket Strainer and Rubber Stopper Spec Sheet (PDF)	
LKOS35	Elkay Polymer 3-1/2" Drain Fitting with Removable Basket Strainer and Rubber Stopper Spec Sheet (PDF)	
LKEC2031	Elkay Explore Single Hole Kitchen Faucet with Pull-down Spray and Forward Only Lever Handle Spec Sheet (PDF)	
LK6000	Elkay Everyday Single Hole Deck Mount Kitchen Faucet with Pull-down Spray Forward Only Lever Handle Spec Sheet (PDF)	

In keeping with our policy of continuing product improvement, Elkay reserves the right to change product specifications without notice. Please visit elkay.com for the most current version of Elkay product specification sheets. This specification describes an Elkay product with design, quality, and functional benefits to the user. When making a comparison of other producers' offerings, be certain these features are not overlooked.