

PRODUCT SPECIFICATIONS

Elkay Quartz Classic[®] 24-5/8" x 18-1/2" x 9-1/2" Single Bowl Undermount Sink Kit. Sink is molded with up to 80% natural quartz and high performance acrylic resins that are non-porous providing superior heat, scratch, fade and stain resistance. Naturally sound deadening and Rear Center drain placement.

Installation Type:	Sink Kits, Undermount
Material:	Quartz
Finish:	Black (BK), Graphite (GT), Matte Black (MB), White (WH)
Number of Bowls:	1
Sink Dimensions:	24-5/8" x 18-1/2" x 9-1/2"
Bowl 1 Dimensions:	22-5/16" x 16-7/16" x 9-1/2"
Drain Size:	3-1/2" (89mm)
Drain Location:	Rear Center
Minimum Cabinet Size:	30"
Mounting Hardware:	Part # 54300404 included
Template Included:	Yes
Cutout Template #:	0000001437

Template is available for download at [elkay.com](#). CAD software will be required to open the template.

Cutout Dimensions for Drop-in Installation:

22-1/2" x 16-5/8" (572mm x 422mm) with 1-1/8" (28mm) corner radius



Installation Profile:

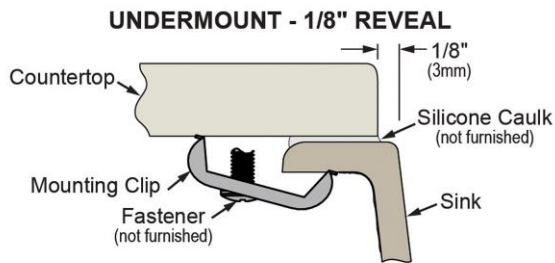

Designed to affix to the underside of any solid surface countertop.

PART: _____ QTY: _____

PROJECT: _____

CONTACT: _____

DATE: _____

NOTES: _____

APPROVAL: _____



Included with Product: LKOBG2217SS Bottom Grid,
LKQS35 Strainer,
LKCLKIT Cleaning Kit

A Century of Tradition and Quality. For more than 100 years, Elkay has been making innovative products and providing exceptional customer care. We take pride in offering plumbing products that make life easier, inspire change and leave the world a better place.





Product Compliance: CSA B45.5/IAPMO Z124
Accessory: ASME A112.18.2/CSA B125.2

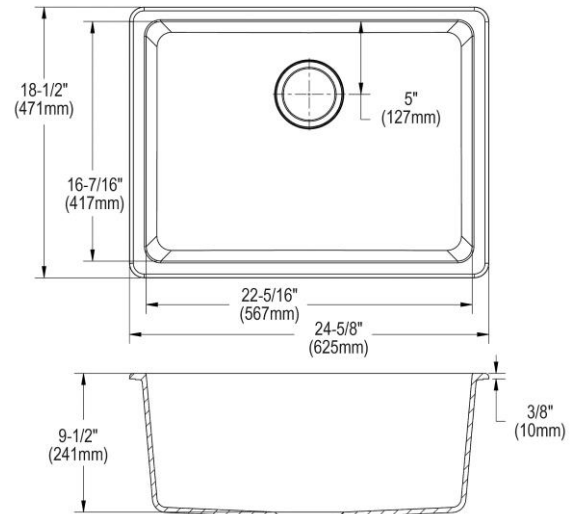



[Clean and Care Manual \(PDF\)](#)
[Installation Instructions \(PDF\) - 1000005238](#)
[Warranty \(PDF\)](#)

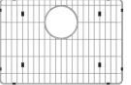

Included Accessories

In keeping with our policy of continuing product improvement, Elkay reserves the right to change product specifications without notice. Please visit [elkay.com](#) for the most current version of Elkay product specification sheets. This specification describes an Elkay product with design, quality, and functional benefits to the user. When making a comparison of other producers' offerings, be certain these features are not overlooked.

LKCLKIT	Sink Cleaning Kit Spec Sheet (PDF)	
LKOBG2217SS	Elkay [®] Stainless Steel 19-13/16" x 13-13/16" x 1-1/4" Bottom Grid Spec Sheet (PDF)	
LKQS35	Elkay [®] Polymer 3-1/2" Drain Fitting with Removable Basket Strainer and Rubber Stopper Spec Sheet (PDF)	

Optional Accessories		
LKOD35	Elkay [®] Polymer 3-1/2" Disposer Flange with Removable Basket Strainer and Rubber Stopper Spec Sheet (PDF)	
LKQS35	Elkay [®] Polymer 3-1/2" Drain Fitting with Removable Basket Strainer and Rubber Stopper Spec Sheet (PDF)	
LKOD35	Elkay [®] Polymer 3-1/2" Disposer Flange with Removable Basket Strainer and Rubber Stopper Spec Sheet (PDF)	
LKQS35	Elkay [®] Polymer 3-1/2" Drain Fitting with Removable Basket Strainer and Rubber Stopper Spec Sheet (PDF)	

In keeping with our policy of continuing product improvement, Elkay reserves the right to change product specifications without notice. Please visit elkay.com for the most current version of Elkay product specification sheets. This specification describes an Elkay product with design, quality, and functional benefits to the user. When making a comparison of other producers' offerings, be certain these features are not overlooked.