

**PRODUCT SPECIFICATIONS**

Elkay Lustertone™ Classic Stainless Steel 30-1/2" x 18-1/2" x 11-1/2" Single Bowl Undermount Sink Kit. Sink is manufactured from 18 gauge 304 Stainless Steel with a Lustrous Satin finish, Rear Center drain placement, and Sides and Bottom pads.

<b>Installation Type:</b>	Sink Kits, Undermount
<b>Material:</b>	304 Stainless Steel
<b>Finish:</b>	Lustrous Satin
<b>Gauge:</b>	18
<b>Sound Deadening:</b>	Sides and Bottom pads
<b>Number of Bowls:</b>	1
<b>Sink Dimensions:</b>	30-1/2" x 18-1/2" x 11-1/2"
<b>Bowl 1 Dimensions:</b>	28" x 16" x 11-1/2"
<b>Drain Size:</b>	3-1/2" (89mm)
<b>Drain Location:</b>	Rear Center
<b>Minimum Cabinet Size:</b>	36"
<b>Mounting Hardware:</b>	Undermount brackets sold separately
<b>Template Included:</b>	Yes
<b>Cutout Template #:</b>	<a href="#">1000001414</a>

Template is available for download at [elkay.com](http://elkay.com). CAD software will be required to open the template.



**Included with Product:** LKWOBG2816SS bottom grid, LK99 drain

A Century of Tradition and Quality. For more than 100 years, Elkay has been making innovative products and providing exceptional customer care. We take pride in offering plumbing products that make life easier, inspire change and leave the world a better place.



**Product Compliance:** ASME A112.19.3/CSA B45.4  
**Accessory:** ASME A112.18.2/CSA B125.2

[Clean and Care Manual \(PDF\)](#)  
[Installation Instructions \(PDF\) - 1000005239](#)  
[Installation Instructions \(PDF\) - 1000005235\\_drain](#)  
[Warranty \(PDF\)](#)

**Installation Profile:**

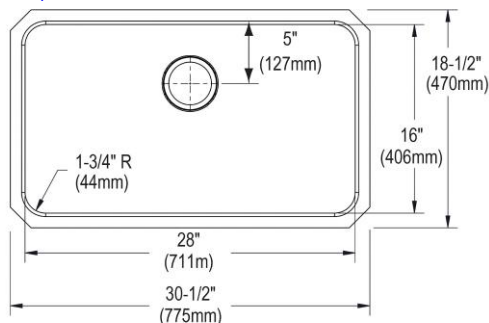
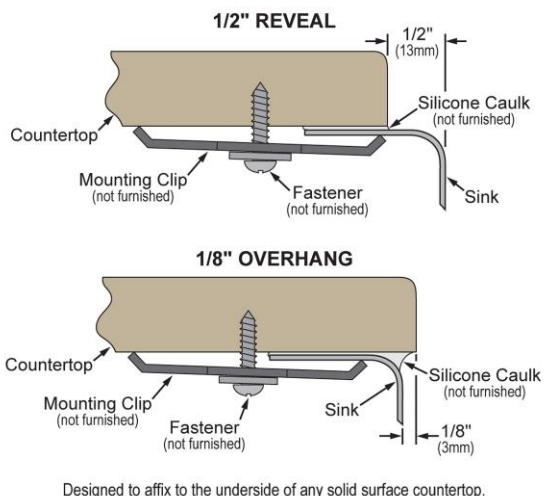



PART: \_\_\_\_\_ QTY: \_\_\_\_\_  
 PROJECT: \_\_\_\_\_  
 CONTACT: \_\_\_\_\_  
 DATE: \_\_\_\_\_  
 NOTES: \_\_\_\_\_  
 APPROVAL: \_\_\_\_\_

**Included Accessories**

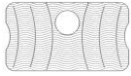
In keeping with our policy of continuing product improvement, Elkay reserves the right to change product specifications without notice. Please visit [elkay.com](http://elkay.com) for the most current version of Elkay product specification sheets. This specification describes an Elkay product with design, quality, and functional benefits to the user. When making a comparison of other producers' offerings, be certain these features are not overlooked.

<a href="#">LK99</a>	Elkay Deluxe 3-1/2" Drain Type 304 Stainless Steel Body Strainer Basket Rubber Seal and Tailpiece <a href="#">Spec Sheet (PDF)</a>	
<a href="#">LKWOBG2816SS</a>	Elkay Stainless Steel 26-1/2" x 14-13/16" x 1" Bottom Grid <a href="#">Spec Sheet (PDF)</a>	

**Optional Accessories**

<a href="#">CB1713</a>	Elkay Hardwood 13-1/2" x 17" x 1" Cutting Board <a href="#">Spec Sheet (PDF)</a>	
<a href="#">CBS1316</a>	Elkay Hardwood 14-1/2" x 17" x 3/4" Cutting Board <a href="#">Spec Sheet (PDF)</a>	
<a href="#">LKGT1041</a>	Elkay Gourmet Single Hole Kitchen Faucet Pull-out Spray and Lever Handle with Hi and Mid-rise Base Options <a href="#">Spec Sheet (PDF)</a>	

*In keeping with our policy of continuing product improvement, Elkay reserves the right to change product specifications without notice. Please visit [elkay.com](http://elkay.com) for the most current version of Elkay product specification sheets. This specification describes an Elkay product with design, quality, and functional benefits to the user. When making a comparison of other producers' offerings, be certain these features are not overlooked.*