

### PRODUCT SPECIFICATIONS

Elkay Wall Mount ADA Cooler Non-filtered Refrigerated Stainless. Chilling Capacity of 8.0 GPH (gallons per hour) of 50° F drinking water, based on 80° F inlet water and 90° F ambient, per ASHRAE 18 testing. Furnished with Flexi-Guard® Safety Bubbler. Electronic Front Bubbler Pushbar activation. Product shall be Wall Mount (On Wall), for Indoor applications, serving 1 station(s). Unit shall be certified to UL 399 and CAN/CSA C22.2 No. 120.

<b>Finish:</b>	Stainless Steel
<b>Power:</b>	115V/60Hz
<b>Bubbler Style:</b>	Flexi-Guard® Safety Bubbler
<b>Activation by:</b>	Electronic Front Bubbler Pushbar
<b>Mounting Type:</b>	Wall Mount (On Wall)
<b>Chilling Capacity*:</b>	8.0 GPH
<b>Full Load Amps</b>	5
<b>Rated Watts:</b>	370
<b>Dimensions (L x W x H):</b>	18-3/8" x 19" x 19-13/16"
<b>Approx. Shipping Weight:</b>	51 lbs.
<b>Installation Location:</b>	Indoor
<b>No. of Stations Served:</b>	1

\*Based on 80° F inlet water & 90° F ambient air temp for 50° F chilled drinking water.

#### COOLING SYSTEM

- Compressor: Hermetically-sealed, reciprocating type, single phase. Sealed-in lifetime lubrication.
- Condenser: Fan cooled, copper tube with aluminum fins. Fan motor is permanently lubricated.
- Cooling Unit: Combination tube-tank type. Continuous copper tubing with is fully insulated with EPS foam that meets UL requirements for self-extinguishing material.
- Refrigerant Control: Refrigerant R-134a is controlled by accurately calibrated capillary tube.
- Temperature Control: Easily accessible enclosed adjustable thermostat is factory preset. Requires no adjustment other than for altitude requirements.



**Included with Product:** Water Cooler  
**Ships in one box.**

A Century of Tradition and Quality. For more than 100 years, Elkay has been making innovative products and providing exceptional customer care. We take pride in offering plumbing products that make life easier, inspire change and leave the world a better place.

#### PRODUCT COMPLIANCE

ADA & ICC A117.1  
ASME A112.19.3/CSA B45.4  
Buy American Act  
CAN/CSA C22.2 No. 120  
NSF/ANSI 61 & 372 (lead free)  
UL 399



[Installation Instructions \(PDF\) - 100002685](#)

**5 Year Limited Warranty** on the refrigeration system of the unit. Electrical components and water system are warranted for 12 months from date of installation. **Warranty pertains to drinking water applications only. Non-drinking water applications are not covered under warranty.**

[Warranty \(PDF\)](#)

PART: \_\_\_\_\_ QTY: \_\_\_\_\_

PROJECT: \_\_\_\_\_

CONTACT: \_\_\_\_\_





DATE: \_\_\_\_\_

NOTES: \_\_\_\_\_

APPROVAL: \_\_\_\_\_

### Optional Accessories

*In keeping with our policy of continuing product improvement, Elkay reserves the right to change product specifications without notice. Please visit [elkay.com](http://elkay.com) for the most current version of Elkay product specification sheets. This specification describes an Elkay product with design, quality, and functional benefits to the user. When making a comparison of other producers' offerings, be certain these features are not overlooked.*

<a href="#">EWF172</a>	Elkay Universal Filtration Kit (1500-Gallon) <a href="#">Spec Sheet (PDF)</a>	
<a href="#">MLP100</a>	In-wall Carrier for Single-station On-wall Bottle Fillers Coolers & Fountains <a href="#">Spec Sheet (PDF)</a>	
<a href="#">LKAPREZL</a>	Elkay Cane Apron for EZ Gray <a href="#">Spec Sheet (PDF)</a>	
<a href="#">97446C</a>	Bubbler Kit Vandal-Resistant <a href="#">Spec Sheet (PDF)</a>	

*In keeping with our policy of continuing product improvement, Elkay reserves the right to change product specifications without notice. Please visit [elkay.com](http://elkay.com) for the most current version of Elkay product specification sheets. This specification describes an Elkay product with design, quality, and functional benefits to the user. When making a comparison of other producers' offerings, be certain these features are not overlooked.*

Open space rough-in design permits new installation or replacement of existing fountains and coolers with this Elkay cooler when rough-in is within the outline shown.

### IMPORTANT! INSTALLER PLEASE NOTE:

This water cooler has been designed and built to provide water to the user which has not been altered by materials in the cooler waterways.

The grounding of electrical equipment such as telephone, computers, etc to water lines is a common procedure. This grounding may be in the building or occur away from the building. This grounding can cause electrical feedback into a water cooler creating an electrolysis which creates a metallic taste or causes an increase in the metal content of the water. This condition is avoidable by installing the cooler using the proper materials as shown below.

### NOTICE

The water cooler must be connected to the water supply using a dielectric coupling. The cooler is furnished with a non-metallic strainer which meets this requirement. The drain trap which is provided by the installer should also be plastic to completely isolate the cooler from the building plumbing system. These products are designed to operate on 20 psi to 105 psi supply line pressure.

### OPERATION OF QUICK CONNECT FITTINGS

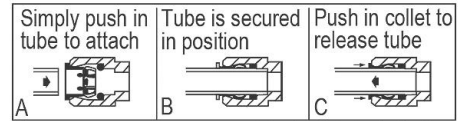

Pushing tube in before pulling it out helps to release tube

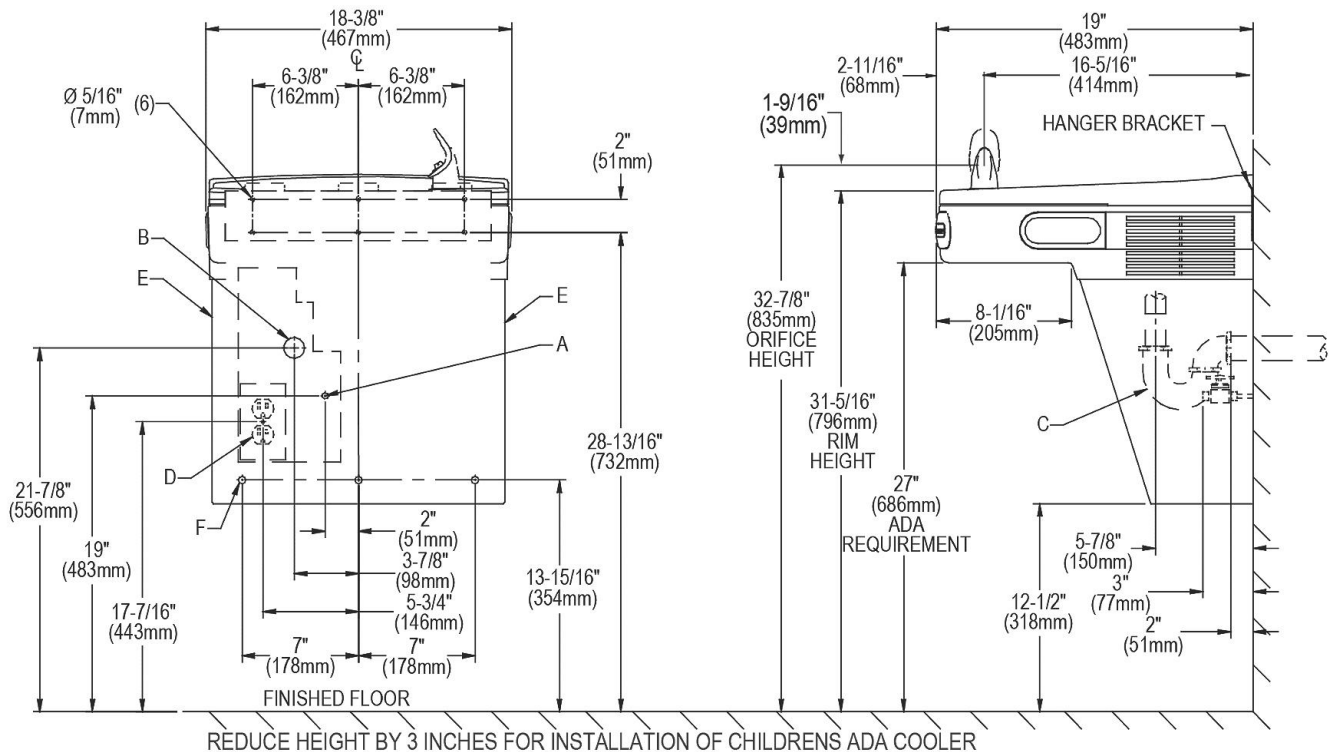
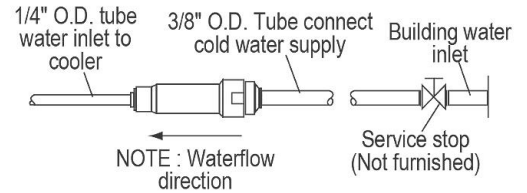

### LEGEND

- A = Recommended water supply location. Shut off valve (not furnished) to accept 3/8" O.D. unplated copper tube connect. Up to 3" (76mm) maximum out from wall.
- B = Recommended waste outlet location. To accommodate 1-1/4" nominal drain. Drain stub 2" (51mm) out form wall.
- C = 1-1/4" Trap (not furnished).
- D = Electrical Supply (3) wire recessed box duplex outlet.
- E = Insure proper ventilation by maintaining 6" (152mm) (MIN.) clearance from cabinet louvers to wall.
- F = 7/16" (11mm) Bolt holes for fastening to wall.

NOTE : New installations must use Ground Fault Circuit Interrupter (GFCI). It is highly recommended that the circuit be dedicated and the load protection be sized for 20 amps.

In keeping with our policy of continuing product improvement, Elkay reserves the right to change product specifications without notice. Please visit [elkay.com](http://elkay.com) for the most current version of Elkay product specification sheets. This specification describes an Elkay product with design, quality, and functional benefits to the user. When making a comparison of other producers' offerings, be certain these features are not overlooked.