

**PRODUCT SPECIFICATIONS**

Elkay Hardwood 15-1/2" x 16-7/8" x 1" Cutting Board. Overall dimensions are 15-1/2" x 16-7/8" x 1". Made of Solid Maple (Hardwood).

Custom designed cutting boards are:

- Designed to securely lock into your sink or countertop opening providing confidence the board will not shift around during use.
- Manufactured from the finest hardwoods grown in a sustainable manner
- Properly sized according to your sink bowl, and built to provide years of daily use.

Cutting board is neither dishwasher nor microwave safe. Since most are designed to sit on the flange of the sink, they are not recommended for undermount sinks that have less than a 1/2" reveal.



AMERICAN PRIDE. A LIFETIME TRADITION.  
Like your family, the Elkay family has values and traditions that endure. For almost a century, Elkay has been a family-owned and operated company, providing thousands of jobs that support our families and communities.



Accessory: Buy American Act

- [Clean and Care Manual \(PDF\)](#)
- [Clean and Care Manual \(PDF\)](#)
- [Warranty \(PDF\)](#)

<b>Material:</b>	Solid Maple (Hardwood)
<b>Dimensions:</b>	15-1/2" x 16-7/8" x 1"
<b>Fits Bowl Size(s):</b>	Fits zero radius bowl size: 16" x 16"

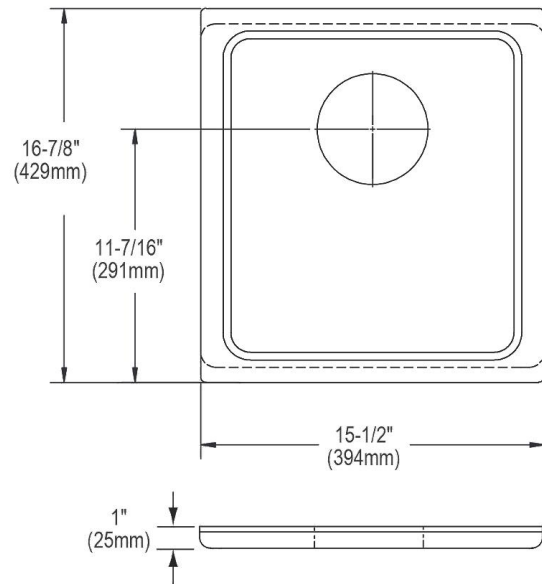

PART: \_\_\_\_\_ QTY: \_\_\_\_\_

PROJECT: \_\_\_\_\_

CONTACT: \_\_\_\_\_

DATE: \_\_\_\_\_

NOTES: \_\_\_\_\_

APPROVAL: \_\_\_\_\_

*In keeping with our policy of continuing product improvement, Elkay reserves the right to change product specifications without notice. Please visit [elkay.com](http://elkay.com) for the most current version of Elkay product specification sheets. This specification describes an Elkay product with design, quality, and functional benefits to the user. When making a comparison of other producers' offerings, be certain these features are not overlooked.*