

PRODUCT SPECIFICATIONS

Elkay ezH2O® Mechanical Bottle Filling Station Surface Mount, Battery Powered Filtered Non-Refrigerated Stainless. Features shall include Antimicrobial, Filtered, Green Ticker™, Laminar Flow, Real Drain, Visual Filter Monitor. Mechanical Bottle Filler Button activation. Product shall be Wall Mount (On Wall), for Indoor applications, serving 1 station(s). Unit shall be lead-free design which is certified to NSF/ANSI 61 & 372 (lead free) and meets Federal and State low-lead requirements.



Special Features:	Antimicrobial, Filtered, Green Ticker™, Laminar Flow, Real Drain, Visual Filter Monitor
Finish:	Stainless Steel
Power:	No Electrical Required
Bubbler Style:	No Bubbler
Activation by:	Mechanical Bottle Filler Button
Mounting Type:	Wall Mount (On Wall)
Chilling Capacity:	Non-refrigerated
Dimensions (L x W x H):	17-7/8" x 6-1/4" x 25-7/8"
Approx. Shipping Weight:	25 lbs.
Installation Location:	Indoor
No. of Stations Served:	1

Special Note: Able to pair with a remote chiller.

- Mechanically-Activated unit continues to supply water in event of service disruptions.
- Visual Filter Monitor: LED Filter Status Indicator for when filter change is necessary.
- Filter is certified to NSF 42 and 53 for lead, particulate, chlorine, taste and odor reduction. 500 gal. capacity.
- Green Ticker: Informs user of number of 20 oz. plastic water bottles saved from waste.
- Laminar flow provides clean fill with minimal splash.
- Silver Ion Antimicrobial protection on key plastic components to inhibit the growth of mold and mildew.
- Real Drain System eliminates standing water.

Included with Product: Bottle Filler (LMASMB), Filter, 3 AA batteries

Ships in one box.

AMERICAN PRIDE. A LIFETIME TRADITION. Like your family, the Elkay family has values and traditions that endure. For almost a century, Elkay has been a family-owned and operated company, providing thousands of jobs that support our families and communities.



PRODUCT COMPLIANCE

ADA & ICC A117.1

Buy American Act

CE

GreenSpec®

NSF/ANSI 42, 53, 61, & 372 (lead free)



Complies with ADA & ICC A117.1 accessibility requirements when installed according to the requirements outlined in these standards. Installation may require additional components and/or construction features to be fully compliant. Consult the local Authority Having Jurisdiction if necessary.

[Installation Instructions \(PDF\)](#)

Water Systems are warranted for 12 months from date of installation.

Warranty pertains to drinking water applications only. Non-drinking water applications are not covered under warranty.

[Warranty \(PDF\)](#)

PART: _____ QTY: _____

PROJECT: _____



CONTACT: _____

DATE: _____

NOTES: _____

APPROVAL: _____

In keeping with our policy of continuing product improvement, Elkay reserves the right to change product specifications without notice. Please visit elkay.com for the most current version of Elkay product specification sheets. This specification describes an Elkay product with design, quality, and functional benefits to the user. When making a comparison of other producers' offerings, be certain these features are not overlooked.

Optional Accessories		
56192C	Elkay Aqua Sentry Replacement Filter Spec Sheet (PDF)	
ECH8	Elkay Remote Chiller, Non-Filtered Refrigerated 8 GPH Spec Sheet (PDF)	
ECH8GRN	Elkay Remote Chiller, Non-Filtered Refrigerated 8 GPH GreenSpec Spec Sheet (PDF)	

In keeping with our policy of continuing product improvement, Elkay reserves the right to change product specifications without notice. Please visit elkay.com for the most current version of Elkay product specification sheets. This specification describes an Elkay product with design, quality, and functional benefits to the user. When making a comparison of other producers' offerings, be certain these features are not overlooked.

IMPORTANT!

INSTALLATION NOTES:

Ensure wall is structurally sound to bear the loads imparted by the Surface Mount Bottle Filler.

These products are designed to operate on 20 psi to 105 psi supply line pressure.

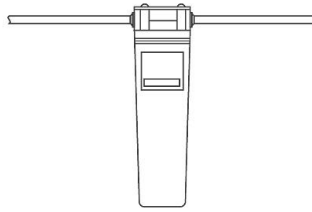

WaterSentry[®] Plus Filter System

OPERATION OF QUICK CONNECT FITTINGS

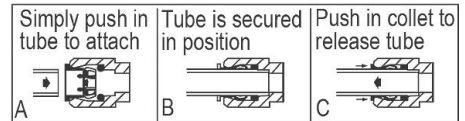

Pushing tube in before pulling it out helps to release tube

ADA Stand Alone Mounting

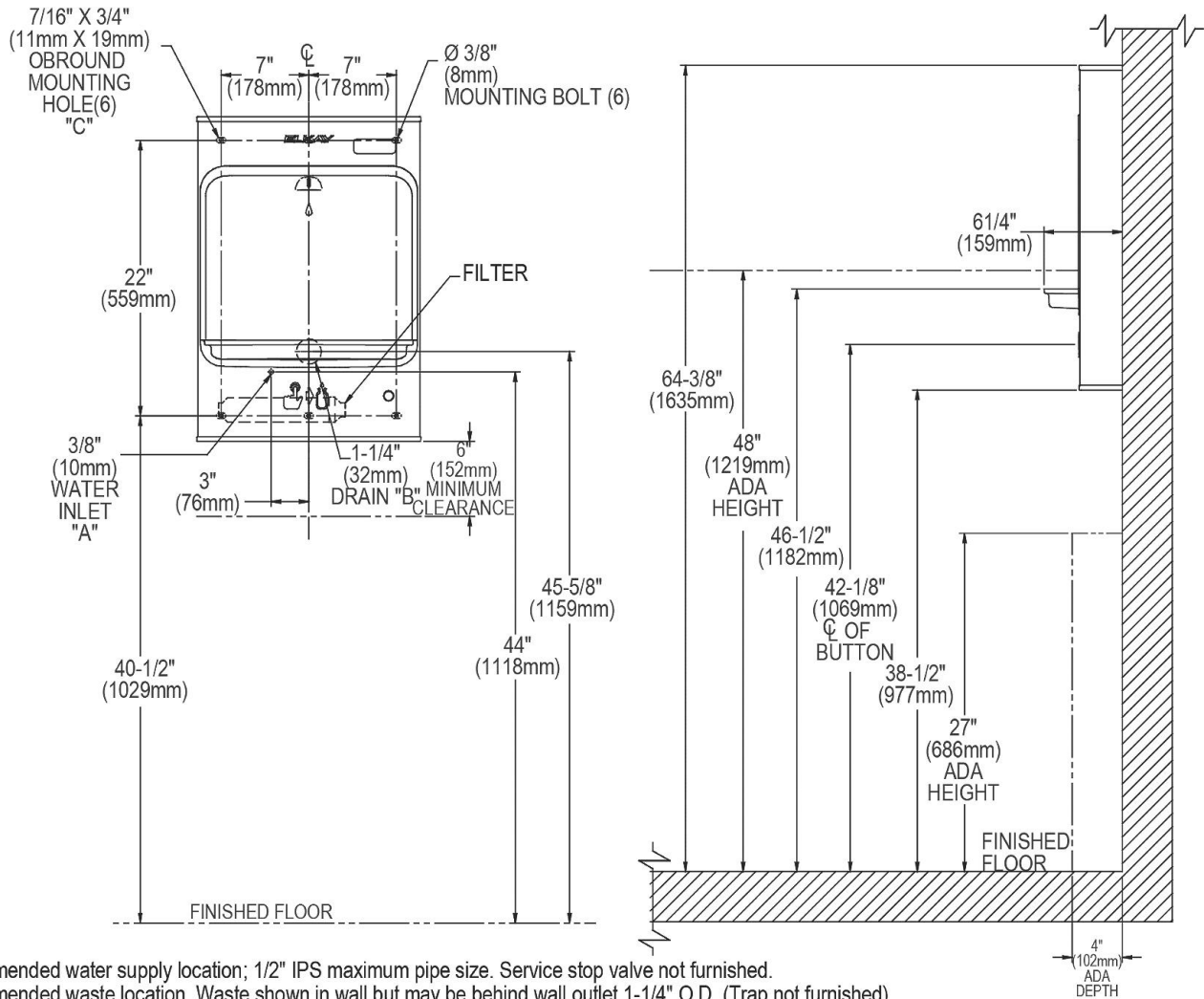

LEGEND:

A = Recommended water supply location; 1/2" IPS maximum pipe size. Service stop valve not furnished.

B = Recommended waste location. Waste shown in wall but may be behind wall outlet 1-1/4" O.D. (Trap not furnished).

C = 7/16" X 3/4" Obround mounting holes for fastening backplate to wall.

NOTE : New Installations Must Use Ground Fault Circuit Interrupter (GFCI). It is highly recommended that the circuit be dedicated and the load protection be sized for 20 amps.

In keeping with our policy of continuing product improvement, Elkay reserves the right to change product specifications without notice. Please visit elkay.com for the most current version of Elkay product specification sheets. This specification describes an Elkay product with design, quality, and functional benefits to the user. When making a comparison of other producers' offerings, be certain these features are not overlooked.

IMPORTANT!

INSTALLATION NOTES:

Ensure wall is structurally sound to bear the loads imparted by the Surface Mount Bottle Filler.

These products are designed to operate on 20 psi to 105 psi supply line pressure.

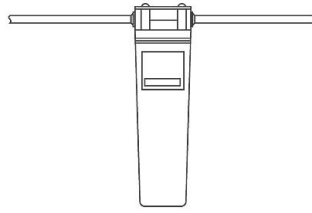

OPERATION OF QUICK CONNECT FITTINGS

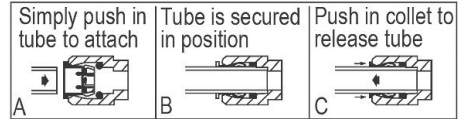

Pushing tube in before pulling it out helps to release tube

ADA Above Cooler Mounting

WaterSentry[®] Plus Filter System

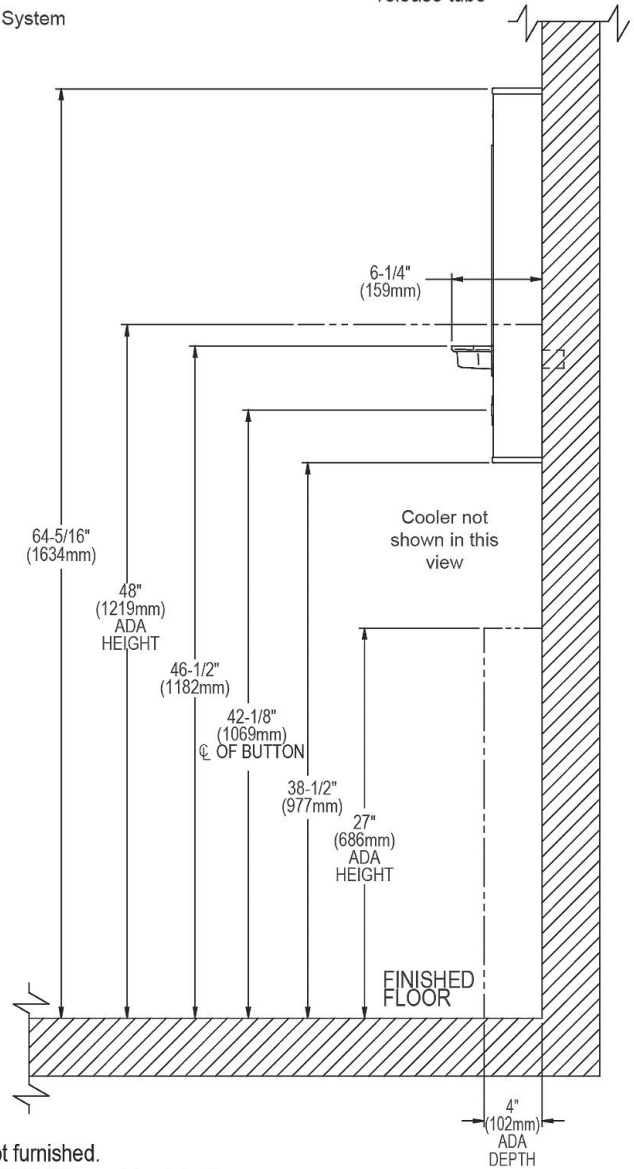
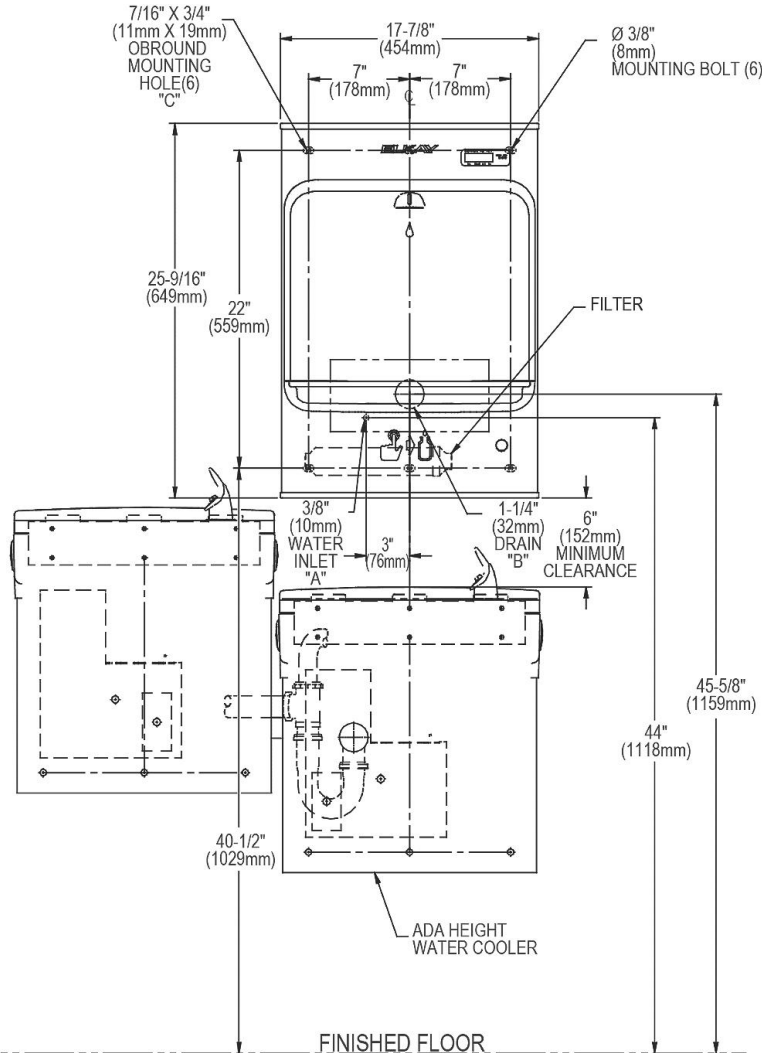

REDUCE HEIGHT BY 3 INCHES FOR INSTALLATION ABOVE CHILDRENS ADA COOLER

LEGEND:

A = Recommended water supply location; 1/2" IPS maximum pipe size. Service stop valve not furnished.

B = Recommended waste location. Waste shown in wall but may be behind wall outlet 1-1/4" O.D. (Trap not furnished).

C = 7/16" X 3/4" Obround mounting holes for fastening backplate to wall.

NOTE : New Installations Must Use Ground Fault Circuit Interrupter (GFCI). It is highly recommended that the circuit be dedicated and the load protection be sized for 20 amps.

In keeping with our policy of continuing product improvement, Elkay reserves the right to change product specifications without notice. Please visit elkay.com for the most current version of Elkay product specification sheets. This specification describes an Elkay product with design, quality, and functional benefits to the user. When making a comparison of other producers' offerings, be certain these features are not overlooked.