

PRODUCT SPECIFICATIONS

Elkay Lustertone™ Classic Stainless Steel 33" x 22" x 10-1/8" Equal Double Bowl Drop-in Sink with Perfect Drain. Sink is manufactured from 18 gauge 304 Stainless Steel with a Lustrous Satin finish, Center drain placement, and Bottom only pads.

Installation Type:	Drop-in
Material:	304 Stainless Steel
Special Features:	Perfect Drain
Finish:	Lustrous Satin
Gauge:	18
Sound Deadening:	Bottom only pads
Number of Bowls:	2
Sink Dimensions:	33" x 22" x 10-1/8"
Bowl 1 Dimensions:	13-1/2" x 16" x 10"
Bowl 2 Dimensions:	13-1/2" x 16" x 7-1/2"
Drain Size:	3-3/8" (86mm)
Drain Location:	Center
Minimum Cabinet Size:	36"
Mounting Hardware:	Part # 64090014 included for countertops up to 3/4" (19mm) thick
Template Included:	No
Cutout Template #:	1000001189

Template is available for download at [elkay.com](#). CAD software will be required to open the template.

Cutout Dimensions for Drop-in Installation:

32-3/8" x 21-3/8" (822mm x 543mm) with 1-1/2" (38mm) corner radius

Perfect Drain: Seamlessly welded stainless steel collar eliminates the gap between a traditional drain and the sink for a sanitary and gap free installation. Select garbage disposers can be installed on either sink bowl for user convenience. Please see our Garbage Disposer Compatibility Guide.

Hole Drilling Configurations:

1-1/2" (38mm) Diameter Faucet Holes on 4" (102mm) Centers

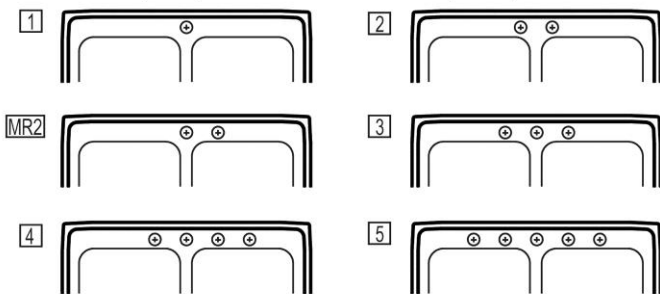

PART: _____ QTY: _____

PROJECT: _____

CONTACT: _____

DATE: _____

NOTES: _____

APPROVAL: _____



Included with Product: Two LKPD1 Perfect Drains and strainers.

A Century of Tradition and Quality.

For more than 100 years, Elkay has been making innovative products and providing exceptional customer care. We take pride in offering plumbing products that make life easier, inspire change and leave the world a better place.

Product Compliance: ASME A112.19.3/CSA B45.4
Buy American Act
Accessory: ASME A112.18.2/CSA B125.2



Sinks are listed by IAPMO® as meeting the applicable requirements of the Uniform Plumbing Code®, International Plumbing Code®, and National Plumbing Code of Canada.

[Clean and Care Manual \(PDF\)](#)

[Installation Instructions \(PDF\) - 74180147](#)

[Installation Instructions \(PDF\) - 74180289 Disposer](#)

[Installation Instructions \(PDF\) - 74180340-USA Drain](#)

[Installation Instructions \(PDF\) -](#)

[Garbage Disposer Compatibility Guide](#)

[Limited Lifetime Warranty \(PDF\)](#)

Similar models are available with: small bowl on the opposite side

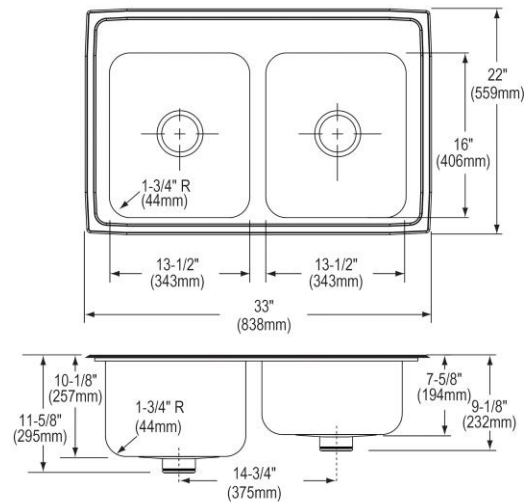

In keeping with our policy of continuing product improvement, Elkay reserves the right to change product specifications without notice. Please visit [elkay.com](#) for the most current version of Elkay product specification sheets. This specification describes an Elkay product with design, quality, and functional benefits to the user. When making a comparison of other producers' offerings, be certain these features are not overlooked.



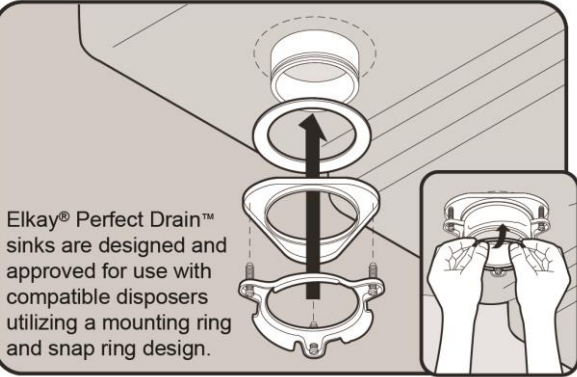
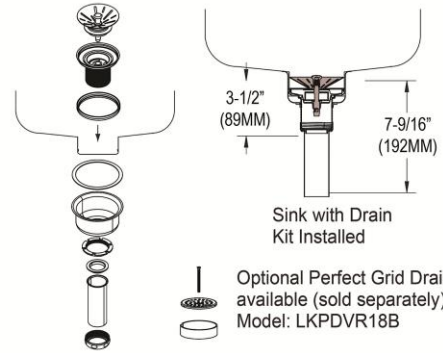
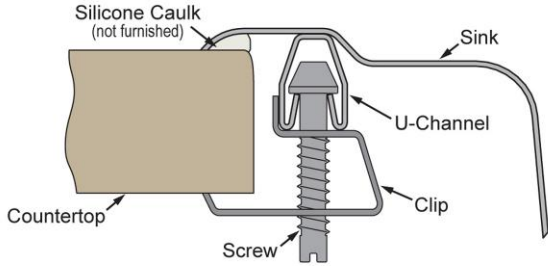

Installation Profile:









Included Accessories

<p>LKPD1</p>	<p>Elkay Perfect Drain Fitting Type 304 Stainless Steel Body and Strainer Spec Sheet (PDF)</p>	
------------------------------	--	--

Optional Accessories

<p>LKWBG1316SS</p>	<p>Elkay Stainless Steel 12-1/2" x 15" x 1" Bottom Grid Spec Sheet (PDF)</p>	
<p>CB1613</p>	<p>Elkay Hardwood 16-3/4" x 13-1/2" x 1" Cutting Board Spec Sheet (PDF)</p>	
<p>CB1713</p>	<p>Elkay Hardwood 13-1/2" x 17" x 1" Cutting Board Spec Sheet (PDF)</p>	
<p>CBS1316</p>	<p>Elkay Hardwood 14-1/2" x 17" x 3/4" Cutting Board Spec Sheet (PDF)</p>	

In keeping with our policy of continuing product improvement, Elkay reserves the right to change product specifications without notice. Please visit elkay.com for the most current version of Elkay product specification sheets. This specification describes an Elkay product with design, quality, and functional benefits to the user. When making a comparison of other producers' offerings, be certain these features are not overlooked.

LKDS35	<p>Elkay 3-1/2" Garbage Disposal Stopper / Strainer for use with Perfect Drain-Satin Finish Spec Sheet (PDF)</p>	
LKDS99	<p>Elkay 3-1/2" Garbage Disposal Stopper / Strainer for use with Perfect Drain-Chrome Polished Stainless Steel Spec Sheet (PDF)</p>	
LKPDVR18B	<p>Elkay Perfect Drain Chrome Plated Brass Body Vandal-resistant Strainer Spec Sheet (PDF)</p>	
LKGT1041	<p>Elkay Gourmet Single Hole Kitchen Faucet Pull-out Spray and Lever Handle with Hi and Mid-rise Base Options Spec Sheet (PDF)</p>	
LKWERBSS	<p>Elkay Stainless Steel 15-3/8" x 12-3/8" x 5-7/16" Rinsing Basket Spec Sheet (PDF)</p>	
LKWRB1316SS	<p>Elkay Stainless Steel 12-1/2" x 15" x 7" Rinsing Basket Spec Sheet (PDF)</p>	
LKSMHSL	<p>Spec Sheet (PDF)</p>	<p>NO IMAGE AVAILABLE</p>

In keeping with our policy of continuing product improvement, Elkay reserves the right to change product specifications without notice. Please visit elkay.com for the most current version of Elkay product specification sheets. This specification describes an Elkay product with design, quality, and functional benefits to the user. When making a comparison of other producers' offerings, be certain these features are not overlooked.