

PRODUCT SPECIFICATIONS

Elkay Weldbilt Stainless Steel 55-1/2" x 27-1/2" x 14" Floor Mount Double Compartment Scullery Sink with Drainboard. Sink is manufactured from 14 gauge 304 Stainless Steel with a Buffed Satin finish, Center drain placement. Sinks supported by (4) 16 gauge stainless steel, 1-5/8" O.D. tubular legs with bullet shaped feet adjustable up to 1".

Material:	304 Stainless Steel
Special Features:	Drainboard
Finish:	Buffed Satin
Gauge:	14
Number of Bowls:	2
Sink Dimensions:	55-1/2" x 27-1/2" x 44"
Bowl 1 Dimensions:	15" x 24" x 14"
Bowl 2 Dimensions:	15" x 24" x 14"
Drainboard Location:	Left
Drainboard Size:	24
Backsplash Height:	8
Leg Type:	Stainless Steel
Drain Size:	3-1/2" (89mm)
Drain Location:	Center



A Century of Tradition and Quality. For more than 100 years, Elkay has been making innovative products and providing exceptional customer care. We take pride in offering plumbing products that make life easier, inspire change and leave the world a better place.



Product Compliance: ASME A112.19.3/CSA B45.4 NSF 2



[Clean and Care Manual \(PDF\)](#)
[Warranty \(PDF\)](#)

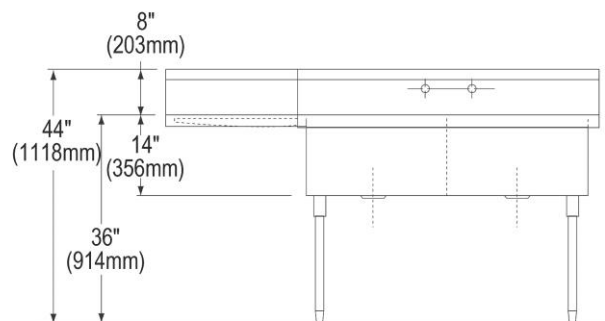
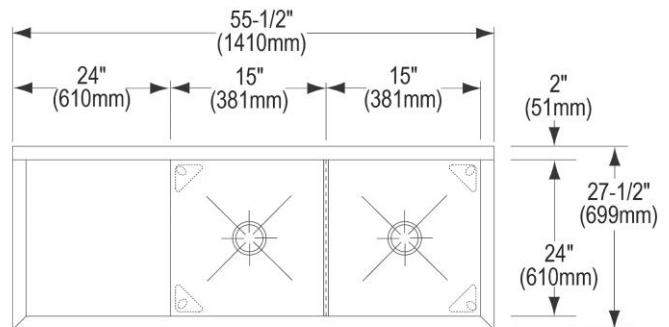

PART: _____ QTY: _____

PROJECT: _____

CONTACT: _____

DATE: _____

NOTES: _____

APPROVAL: _____

In keeping with our policy of continuing product improvement, Elkay reserves the right to change product specifications without notice. Please visit elkay.com for the most current version of Elkay product specification sheets. This specification describes an Elkay product with design, quality, and functional benefits to the user. When making a comparison of other producers' offerings, be certain these features are not overlooked.