

ELKAY® SPECIFICATIONS

Weldbilt® Double Compartment Scullery Sink 1/4-Inch Radius Coved Corner

GENERAL

Model No. WNSF_____ #14 gauge, type 304, (18-8) stainless steel scullery sink. Compartments 14" deep. Welded 1/4" radius coved corner construction. Welds are ground to a smooth and cleanable finish. Full length 8" high backsplash with 45° sloped top. 1-1/2" wide inward sloping top channel rims. Integral drainboard/s, sink compartments pitched to drain. Exposed surfaces polished to a satin finish. Weldbilt sinks carry the NSF International Certification.

Sinks supported on (4) **LK251** stainless steel, 1-5/8" O.D. tubular legs, #16 gauge wall thickness. Adjustable bullet shaped feet.

 Shaded models are normally carried in stock with standard faucet location.

 Non-shaded models with specified dimensions are considered standard models which must be made to order—standard faucet location unless otherwise specified.

 Last item in each group is custom. Fill in dimensions. Standard faucet location unless otherwise specified.

Drainboards over 25-1/2" long furnished with one tubular leg.

Drainboards over 48" long furnished with two tubular legs.

SPECIFIED FITTINGS:

SUPPLY:

DRAIN:

ALL DIMENSIONS IN INCHES.

SEE OTHER SIDE FOR DIMENSIONS IN MILLIMETERS.

(Check Model Specified):

NO DRAINBOARD

Model Number	Dimensions	
	A	B
WNSF8230	33	15
WNSF8236	39	18
WNSF8242	45	21
WNSF8248	51	24
WNSF8254	57	27
WNSF8260	63	30
• WCNSF8200		

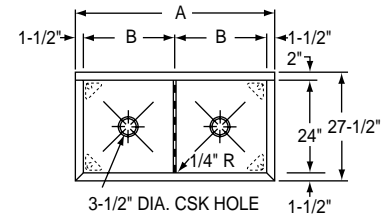

RIGHT DRAINBOARD

Model Number	Dimensions		
	A	B	C
WNSF8230R	55 1/2	15	24
WNSF8236R	61 1/2	18	24
WNSF8248R	73 1/2	24	24
WNSF8254R	79 1/2	27	24
WNSF8260R	85 1/2	30	24
• WCNSF8200R			

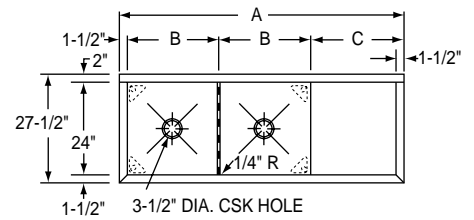

LEFT DRAINBOARD

Model Number	Dimensions		
	A	B	C
WNSF8230L	55 1/2	15	24
WNSF8236L	61 1/2	18	24
WNSF8248L	73 1/2	24	24
WNSF8254L	79 1/2	27	24
WNSF8260L	85 1/2	30	24
• WCNSF8200L			

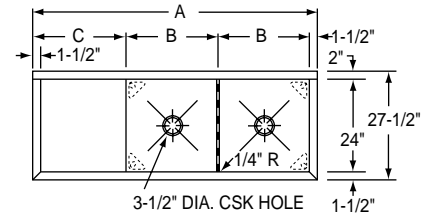

RIGHT & LEFT DRAINBOARD

Model Number	Dimensions		
	A	B	C
WNSF8230LR	78	15	24
WNSF8236LR	84	18	24
WNSF8248LR	96	24	24
WNSF8254LR	102	27	24
WNSF8260LR	108	30	24
• WCNSF8200LR			

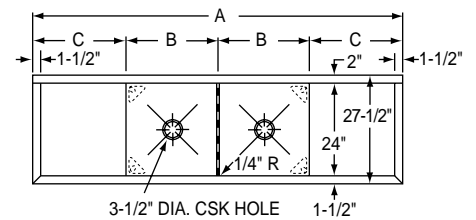

INDICATE NUMBER OF FAUCET HOLES WHEN PLACING ORDER. (NON-STANDARD FAUCET AND OVERFLOW DRILLING LOCATIONS ARE AVAILABLE. SPECIFY ON DRAWING AT RIGHT.)

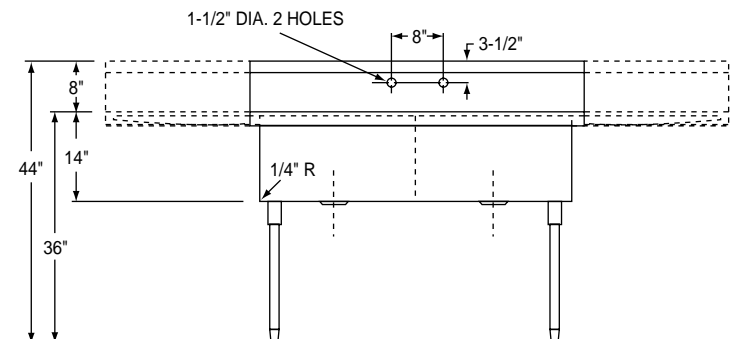

Weldbilt® Double Compartment Scullery Sink 6mm Radius Coved Corner

ELKAY® SPECIFICATIONS

GENERAL

Model No. WNSF_____ #14 gauge, type 304, (18-8) stainless steel scullery sink. Compartments 356mm deep. Welded 6mm radius coved corner construction. Welds are ground to a smooth and cleanable finish. Full length 203mm high backsplash with 45° sloped top. 38mm wide inward sloping top channel rims. Integral drainboard/s, sink compartments pitched to drain. Exposed surfaces polished to a satin finish. Weldbilt sinks carry the NSF International Certification.

Sinks supported on (4) **LK251** stainless steel, 41mm O.D. tubular legs, #16 gauge wall thickness. Adjustable bullet shaped feet.

Shaded models are normally carried in stock with standard faucet location.

Non-shaded models with specified dimensions are considered standard models which must be made to order—standard faucet location unless otherwise specified.

Last item in each group is custom. Fill in dimensions. Standard faucet location unless otherwise specified.

Drainboards over 648mm long furnished with one tubular leg.

Drainboards over 1,219mm long furnished with two tubular legs.

SPECIFIED FITTINGS:

SUPPLY:

DRAIN:

ALL DIMENSIONS IN MILLIMETERS.
SEE OTHER SIDE FOR DIMENSIONS IN INCHES.

(Check Model Specified):

NO DRAINBOARD

Model Number	Dimensions	
	A	B
WNSF8230	838	381
WNSF8236	991	457
WNSF8242	1143	533
WNSF8248	1295	610
WNSF8254	1448	686
WNSF8260	1600	762
• WCNSF8200		

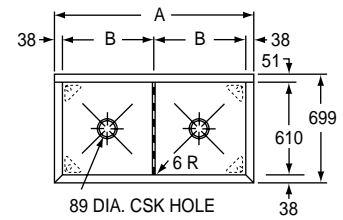

RIGHT DRAINBOARD

Model Number	Dimensions		
	A	B	C
WNSF8230R	1410	381	610
WNSF8236R	1562	457	610
WNSF8248R	1867	610	610
WNSF8254R	2019	686	610
WNSF8260R	2172	762	610
• WCNSF8200R			

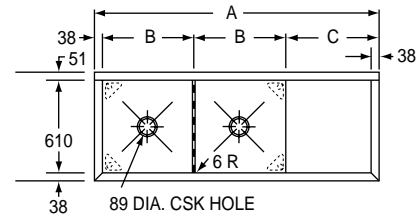

LEFT DRAINBOARD

Model Number	Dimensions		
	A	B	C
WNSF8230L	1410	381	610
WNSF8236L	1562	457	610
WNSF8248L	1867	610	610
WNSF8254L	2019	686	610
WNSF8260L	2172	762	610
• WCNSF8200L			

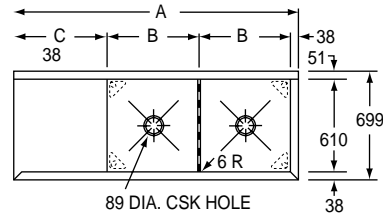

RIGHT & LEFT DRAINBOARD

Model Number	Dimensions		
	A	B	C
WNSF8230LR	1981	381	610
WNSF8236LR	2134	457	610
WNSF8248LR	2438	610	610
WNSF8254LR	2591	686	610
WNSF8260LR	2743	762	610
• WCNSF8200LR			

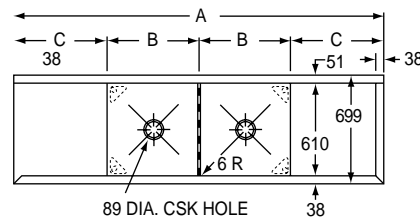

INDICATE NUMBER OF FAUCET HOLES WHEN PLACING ORDER. (NON-STANDARD FAUCET AND OVERFLOW DRILLING LOCATIONS ARE AVAILABLE. SPECIFY ON DRAWING AT RIGHT.)

